

# P-touch 530/550

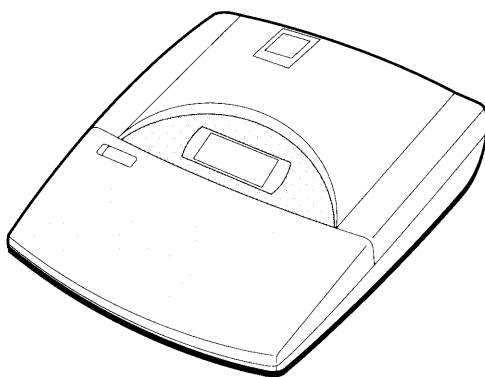

## USER'S GUIDE

- Read this User's Guide before you start using your P-touch.
- Keep this User's Guide in a handy place for future reference.

**brother**®

# PREFACE

Thank you for purchasing the P-touch 530/550!

With your new P-touch, you can create labels and stamps for any need. Select from the many frames, character sizes and styles to design beautiful custom labels and stamps. In addition, the variety of tape and ink colors available allow you to print personalized labels, useful for color-coding.

You no longer have to worry about urgent tasks that require professional printing. In the office, the factory, the lab or the home, the quality and performance of the P-touch 530/550 makes it an extremely practical machine.

Finally, as you may want to refer to this User's Guide occasionally, we suggest that you keep it in a handy place.

## FCC NOTICE

This equipment has been tested and found to comply with the limits for a Class B digital device, pursuant to 15 of the FCC Rules. These limits are designed to provide reasonable protection against harmful interference in a residential installation. This equipment generates, uses, and can radiate radio frequency energy and, if not installed and used in accordance with the instructions, may cause harmful interference to radio communications. However, there is no guarantee that interference will not occur in a particular installation. If this equipment does cause harmful interference to radio or television reception, which can be determined by turning the equipment off and on, the user is encouraged to try to correct the interference by one or more of the following measures:

Reorient or relocate the receiving antenna.

Increase the separation between the equipment and receiver.

Connect the equipment into an outlet on a circuit different from that to which the receiver is connected.

Consult the dealer or an experienced radio/TV technician for help.

The enclosed interface cable should be used in order to ensure compliance with the limits for a Class B digital device.

Changes or modifications not expressly approved by Brother Industries, Ltd. Could void the user's authority to operate the equipment.

**This product is covered by one or more of the following patents.**

**USP4839742**

**USP4983058**

**EP315369**

**GB2223740**

**USP4922063**

**USP5009530**

**EP322918**

**USP4927278**

**USP5069557**

**EP322919**

**USP4966476**

**USP5120147**

**USP4976558**

# CONTENTS

<b>ABOUT THIS MANUAL</b> .....	<b>1</b>
--------------------------------	----------

## **QUICK REFERENCE GUIDE**

### **BEFORE YOU START**

MACHINE DIAGRAM.....	8
GENERAL PRECAUTIONS .....	10
BATTERIES.....	11
OPTIONAL AC ADAPTOR .....	12
TAPE CASSETTE .....	13
ATTACHING LABELS.....	16
PRINT HEAD AND ROLLERS.....	19

### **LEARNING THE ROPES**

INTRODUCTION .....	22
NAME TAG EXAMPLE .....	23
EQUIPMENT LABEL EXAMPLE .....	30
ADDRESS LABEL EXAMPLE .....	36
STORAGE SHELF LABEL EXAMPLE .....	45

### **FOR YOUR INFORMATION**

INTRODUCTION .....	54
FINDING YOUR WAY .....	55
On/Off KEY .....	56
CURSOR KEYS .....	57
Code/Alt/Shift KEYS AND Caps MODE .....	59
Space KEY .....	62
RETURN KEY .....	63
New Block FUNCTION.....	66
Cancel KEY.....	68
BS (BACKSPACE) KEY .....	71
Line Out FUNCTION .....	72
Clear FUNCTION.....	73
Symbol FUNCTION .....	75
Accent FUNCTION .....	78

Barcode FUNCTION .....	80
Zoom KEY .....	85
Contrast KEY .....	86
Label length FUNCTION .....	87
Auto Formats Key .....	88
Area KEY AND ALL FUNCTION .....	97
Font KEY .....	100
Size AND Width KEYS .....	102
Style KEY .....	104
Undl/Frm (UNDERLINE/FRAME) KEY .....	107
Color KEY .....	109
Format KEY .....	110
GLOBAL FRAME FUNCTION .....	112
FRAME COLOR FUNCTION .....	113
STYLE COLOR FUNCTION .....	114
LENGTH FUNCTION .....	116
FEED (TAPE FEED) FUNCTION .....	117
H.ALI (HORIZONTAL ALIGNMENT) FUNCTION .....	118
VERT (VERTICAL PRINTING) FUNCTION .....	119
MIRROR (MIRROR PRINTING) FUNCTION .....	120
UNIT FUNCTION .....	121
Print KEY AND Tape Cut KEY .....	122
COLOR PRINT FUNCTION .....	123
Stamp FUNCTION .....	125
Special Print FUNCTION .....	128
Seq. Numbering FUNCTION .....	130
Store, Recall AND M.Del KEYS .....	134
<b>ERROR MESSAGE LIST .....</b>	<b>139</b>
<b>TROUBLESHOOTING .....</b>	<b>146</b>
<b>MACHINE SPECIFICATIONS .....</b>	<b>147</b>
<b>FEATURES .....</b>	<b>148</b>
<b>INDEX .....</b>	<b>149</b>
<b>ACCESSORIES .....</b>	<b>152</b>

# ABOUT THIS MANUAL

Although the P-touch 530/550 is easy to use, we suggest that you read this manual carefully before starting. This manual consists of a reference guide and three chapters:

<b>QUICK REFERENCE GUIDE</b>	This guide provides quick and simple instructions on setting up and using the machine.
<b>BEFORE YOU START</b>	This chapter provides basic information concerning the tape cassettes, power supplies, and labels.
<b>LEARNING THE ROPES</b>	The easy-to-follow practice sessions in this chapter are designed to help you become familiar with the machine's operations.
<b>FOR YOUR INFORMATION</b>	This handy reference chapter contains detailed explanations of all the machine's features.

The *Quick Reference Guide* contains all the information you need to immediately begin using this machine for making simple labels. Please read the brief *Before You Start* chapter for more details on the setup and care of the machine.

If this is your first time using a P-touch or if you would like to brush up on some techniques, we suggest you work through the exercises in *Learning the Ropes*. If you have detailed questions about specific features, the *For Your Information* chapter will provide you with the answers.

We hope you enjoy using your P-touch 530/550.

## QUICK REFERENCE GUIDE

### Power Supply (Refer to pages 11 and 12 for details.)

#### Inserting the Batteries

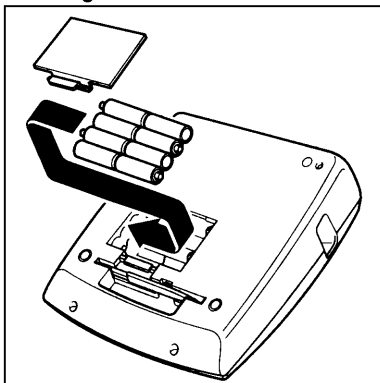

Remove the battery cover on the back of the machine and insert eight **AA alkaline batteries**.

#### Connecting the Optional AC Adaptor

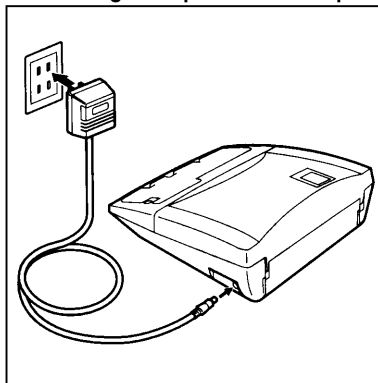

Insert the adaptor plug (model AD-60, sold separately) into the jack on the machine, then insert the AC adaptor into the outlet.

### Tape Cassettes (Refer to pages 13 to 15 for details.)

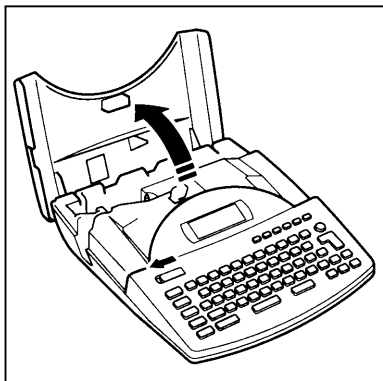

1. Slide the cover release lever to the left, then lift open the cover.

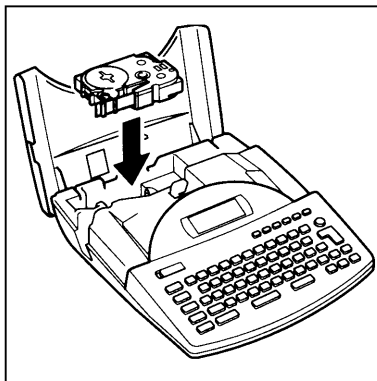

2. Insert a TZ tape cassette, then close the cover.

# Mr. J. Smith

1. Press .

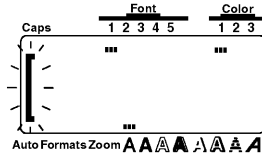

2. Type in "Mr. J. Smith".

a. Press  + .

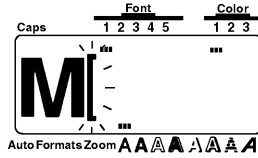



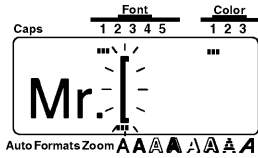

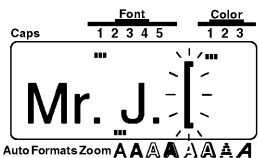

b. Press , , then .



c. Press  + . Next, press , then .



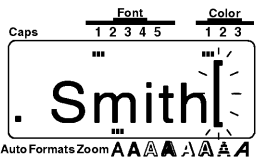

d. Press  + . Then, press , ,  and finally .

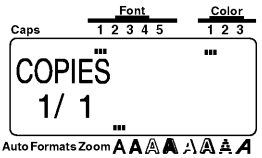

3. After entering the text, print out the label.

Press .



 To print multiple copies of the same label,

press  +  and use  and

 to set the number of copies to be

printed, then press .

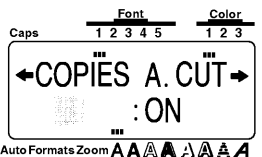

4. Affix the label

- a. After the label is printed and automatically cut, remove it from the tape exit slot.

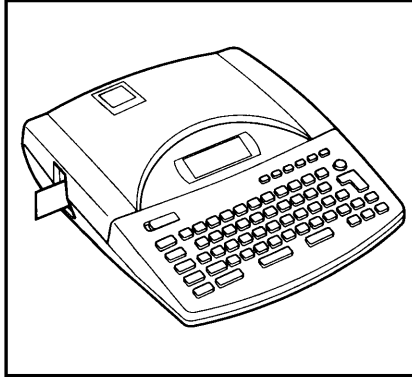

- b. Use the enclosed lettering stick to remove the backing from the label.

☛ *The lettering stick is attached to the bottom of the P-touch.*

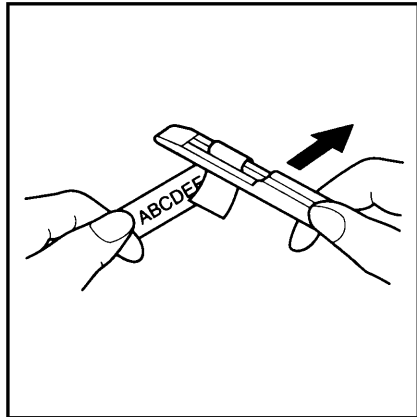
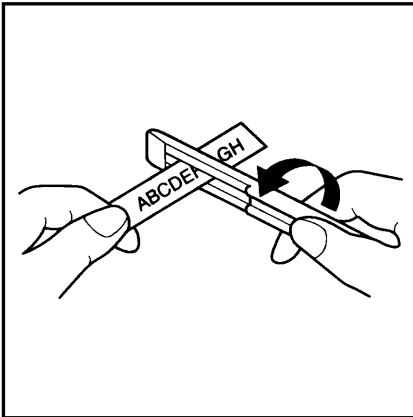



c. Attach the label at the desired position.

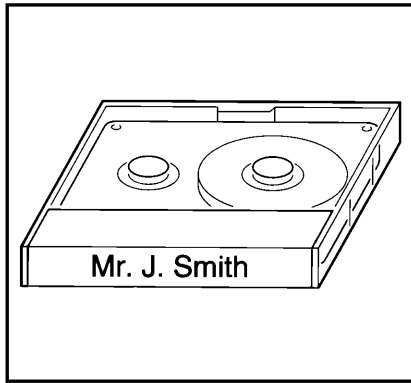

**Demo printing** ( To print a demo label, press  +  . )

**P-TOUCH** *EXTRA*

*Electronic Labeling System*  
Easy, Beautiful & Versatile



☞ Since four different demo labels are available, the label that is printed depends on the width of the installed tape.



***Before You  
Start***

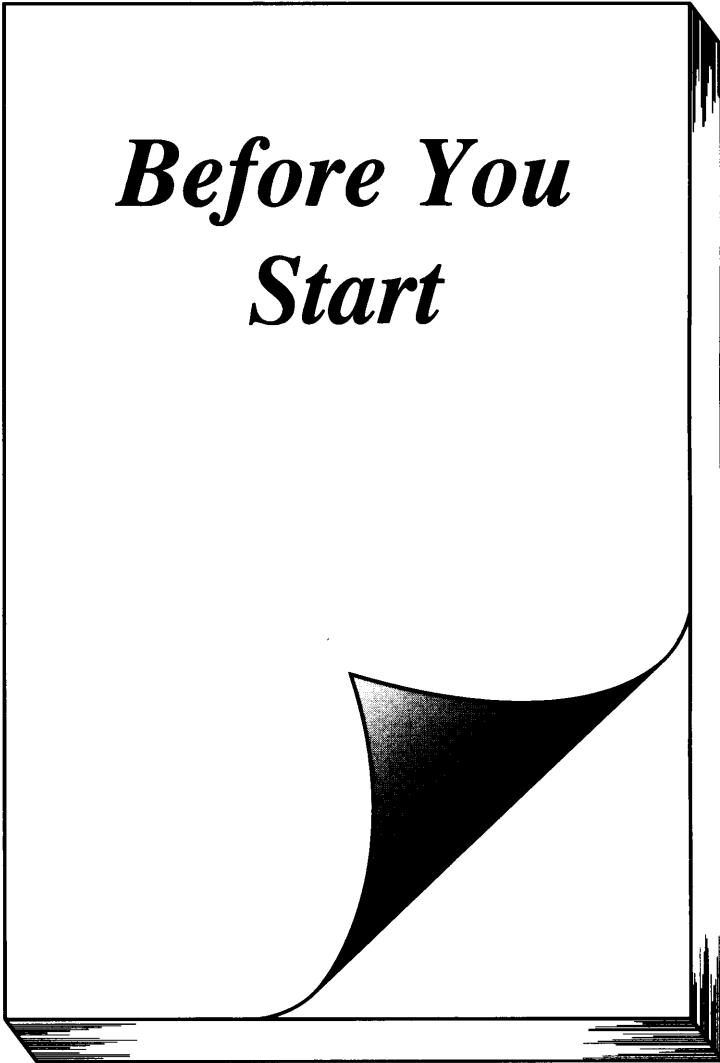

# MACHINE DIAGRAM

## KEYBOARD

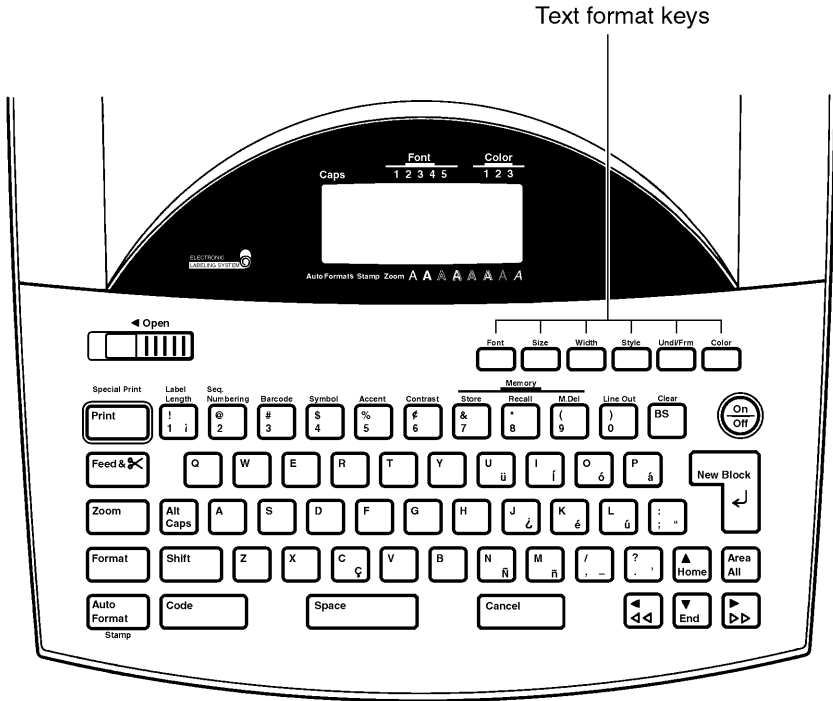

Text format keys

## LCD DISPLAY

P-touch 530

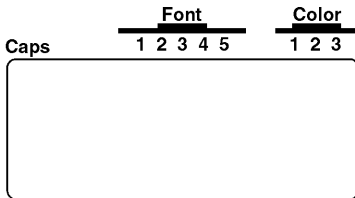

P-touch 550

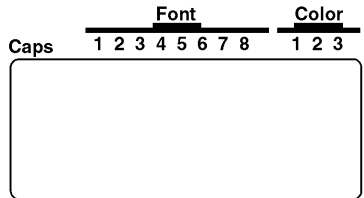

# FEATURES

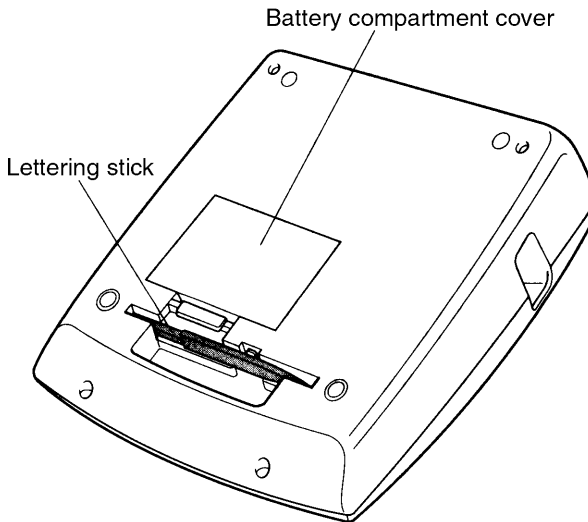
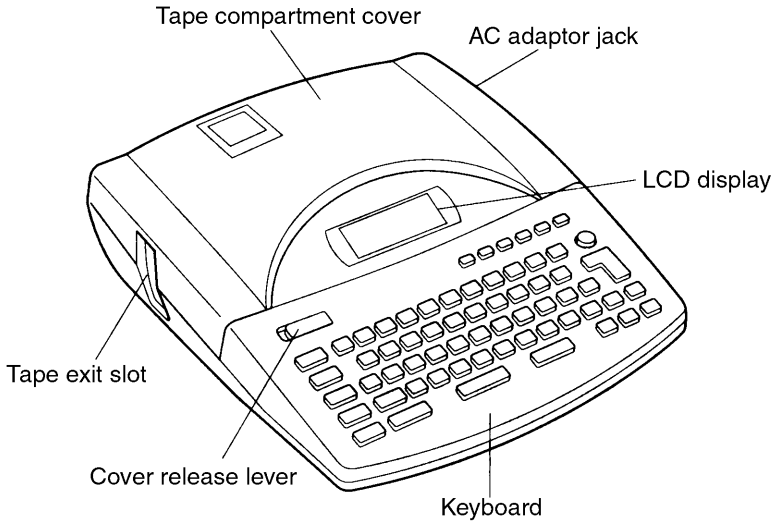

A clear protective film has been affixed to the LCD display to prevent it from being scratched or damaged. Before operating the machine, remove the film.

# GENERAL PRECAUTIONS



- \* Use only Brother TZ tapes with this machine. Do not use tapes that do not have the mark.
- \* Do not pull on the tape being fed from the P-touch. Doing so may damage the tape cassette.
- \* Avoid using the machine in extremely dusty place. Keep in out of both direct sunlight and rain.
- \* When printing a label, a horizontal line appears on your label, this may be an indication that dust is on the print head. To clean the print head, gently rub a cotton swab over the print head to remove dust. (See page 19.)
- \* Be sure tape is properly fed through tape guidelines before installing a tape into the machine. (See page 15.)
- \* Do not expose the machine to high temperatures or high humidity. Never leave it on the dashboard or in the back of your car.
- \* Do not leave any rubber or vinyl on the machine for an extended period of time. Doing so may cause staining.
- \* Do not put any foreign objects onto or into the machine.
- \* To avoid injuries, do not touch the cutter's edge.
- \* When inserting new batteries, be sure to do so within five minutes of removing the old ones, otherwise all text files will be lost (unless the machine is plugged into an AC outlet with the AC adapter).
- \* Use only the AC adapter (model AD-60) designed exclusively for this machine. Use of any other adapter will void the warranty.
- \* When the machine is not being used for a long period of time and it is not necessary to keep the text files stored in the memory, disconnect the AC adapter, and remove the batteries to prevent them from leaking and damaging the machine.
- \* If the adapter is removed from the AC outlet before unplugging in from the machine, the text files in the memory will not be deleted if the batteries are correctly installed.
- \* **Use only AA alkaline batteries in this machine.**

# BATTERIES

This lightweight and portable machine can be used anywhere by installing eight (8) **AA Alkaline batteries**. When you change the batteries, always replace all eight at the same time.

## TO CHANGE THE BATTERIES:

- ➊ Remove the battery compartment cover on the back of the machine.
- ➋ If batteries are already installed, remove them.
- ➌ **Insert eight new AA alkaline batteries, making sure that they face the correct direction.**
- ➍ Attach the battery compartment cover.

⚠ *Be sure to insert the new batteries within five minutes of removing the old ones, otherwise the text shown in the display and any text files stored in the memory will be lost (unless the machine is plugged into an AC output with the AC adaptor).*

**Use only AA alkaline batteries in this machine.**

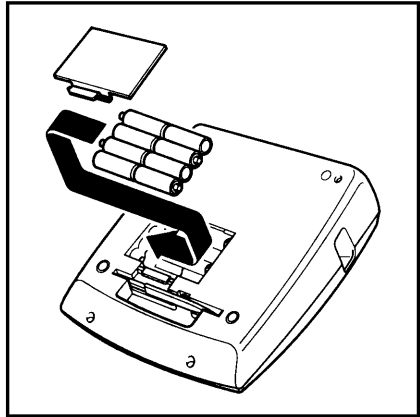
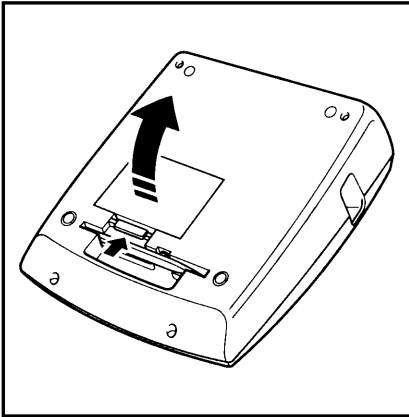

## OPTIONAL AC ADAPTOR

The AC adaptor (Model AD-60) allows you to use this machine anywhere a standard electrical outlet is available.

### TO CONNECT THE AC ADAPTOR:

- 1 Insert the small plug on the adaptor into the jack marked DC IN 9.5V on the right side of the machine.
  - 2 Insert the large plug into the nearest standard electrical outlet.
- ⚠ *Only use the AC adaptor designed exclusively for this machine.*

*If the adaptor is removed from the AC outlet before unplugging it from the machine, the text files in the memory will not be deleted if batteries are correctly installed.*

*It is recommended that the AC adaptor be connected before printing large fonts and bar codes on 3/4"(18-mm)-, 1"(24-mm)- or 1 1/2"(36-mm)-wide tape since these operations can quickly drain batteries.*

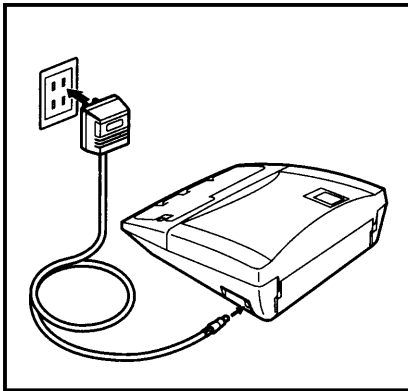





# TAPE CASSETTES

A single TZ tape cassette is supplied with this unit. However, since TZ tape cassettes as well as color printing ink and tape cassettes are available for this machine in a wide variety of colors and sizes, it is possible to make distinctive color-coded and stylized labels. In addition, this machine has been designed to allow you to change the tape cassettes quickly and easily.

## TO CHANGE A TZ TAPE CASSETTE:

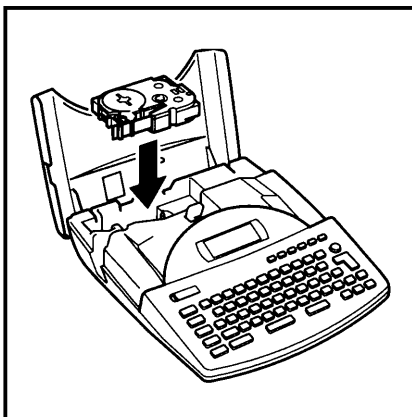
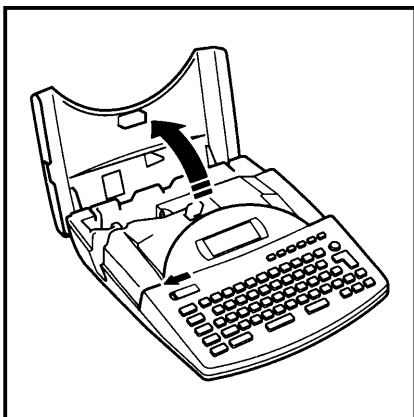

- 1 Slide the cover release lever to the left, then lift open the tape compartment cover.
- 2 If a tape cassette is already installed, remove it by pulling it straight up.
- 3 If the ink ribbon in the other tape cassette is loose, use your finger to wind the toothed wheel in the direction of the arrow on the cassette until there is no slack in the ribbon. Also, make sure that the end of the tape feeds under the tape guides.  
*✎ If you are using a new cassette, first remove the stopper.*
- 4 Insert the tape cassette firmly into the compartment, making sure that the entire back of the cassette touches the bottom of the compartment.  
*✎ When inserting the tape cassette, make sure that the inner ribbon does not catch on the corner of the metal guide.*
- 5 Close the compartment cover, then press  to turn on the machine if it is off.
- 6 Press  once to remove any slack in the tape and cut off the excess.



## TO CHANGE THE COLOR PRINTING INK AND TAPE CASSETTE:

- 1 Slide the cover release lever to the left, then lift open the tape compartment cover.
- 2 If a tape cassette is already installed, remove it by pulling it straight up.
- 3 Insert the ink cassette straight down into the cassette.
  - ☞ If the ribbon in the ink cassette is loose, use your finger to wind the toothed wheel in the direction of the arrow on the ink cassette until there is no slack in the ribbon.

If you are using a new tape cassette, remove the adhesive tape from the end of the tape and pull out about 1/2" (12-mm) of label tape.

If you are using an old tape cassette, be sure that the is correctly fed. (for details, refer to page 15.)
- 4 Insert both the ink and tape cassettes firmly into the compartment, making sure that the entire back of the cassettes touch the bottom of the compartment.
  - ☞ When inserting the cassettes, make sure that the ink ribbon does not catch on the corner of the metal guide and that the tape does not catch on the cutter.
- 5 Close the compartment cover, then press  to turn on the machine if it is off.
- 6 Press  once to remove any slack in the tape and cut off the excess.

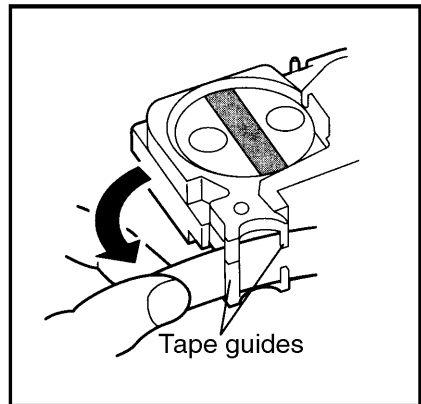
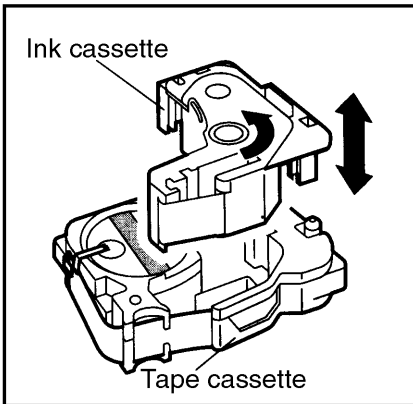

## Feeding the tape through the cassette

- 1 Remove the tape and ink cassettes from the machine, then take the ink cassette out of the tape cassette.
- 2 Guide the tape into the cassette case.

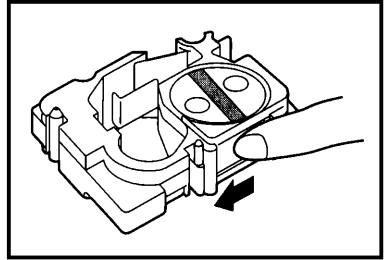

*☞ If there is only a little tape left in the cassette, pull out more and feed it into the slot.*

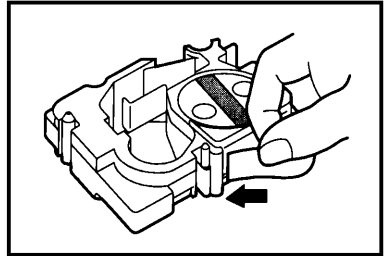

- 3 Guide the end of the tape through the slot and around the cassette case.

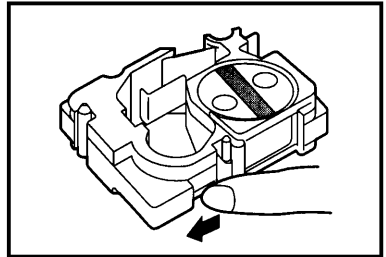

- 4 Slide the tape under the tape guides.

*☞ Make sure the tape feeds under the tape guides.*

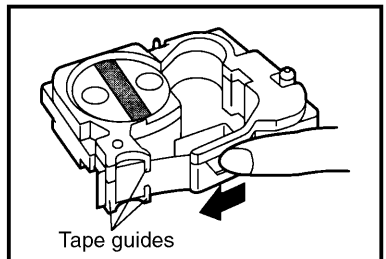

- 5 Hold the end of the tape and turn the tape roll counterclockwise to remove any slack.

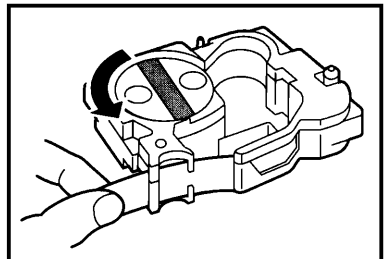

# ATTACHING LABEL

## LAMINATED TAPE

The enclosed lettering stick enables you to easily remove the backing from labels printed on laminated tapes.

- 1 Hold the tape in your left hand, with the printed surface facing up, and hold the lettering stick in your right hand.
- 2 Pass the tape halfway through the long narrow hole in the stick.
- 3 Turn the stick three quarters of a turn towards you and pull the stick away from you as shown below.
- 4 Peel off the label backing.

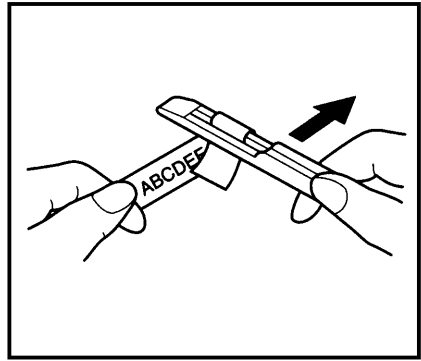
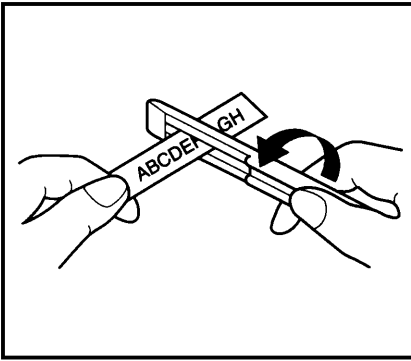

## NON-LAMINATED TAPE

Labels printed on non-laminated tapes can be folded in half so that the inside edges of the two backing pieces come off the label, enabling the backing to easily be peeled off.

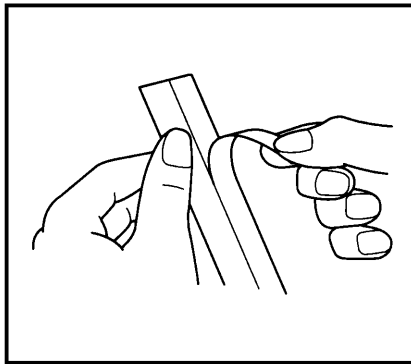

## INSTANT-LETTERING TAPE (RUB-ON TRANSFERS)

Instant-lettering tape can be used to transfer your text onto paper. After printing the text onto instant-lettering tape and cutting off the labels, position it on a sheet of paper. By simply rubbing the instant lettering tape's non-printed side with the enclosed lettering stick, you can transfer the text directly onto the paper.

 Hold the tape very firmly and do not move it while rubbing the tape.

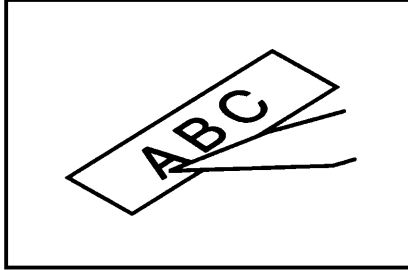

## IRON-ON TRANSFER TAPE

Iron-on transfer tape can be used to transfer your text onto garments using an iron.

 Although the iron-ons are non-toxic, you should maintain the usual precautions and not place them in your mouth.

*Do not store iron-on transfer tape cassettes in areas exposed to direct sunlight, high humidity or dust.*

- 1 Insert an iron-on transfer tape cassette, press  to print the text, then cut off the label.
- 2 Iron the garment to flatten it before transferring the text.
- 3 Place the label on the garment at the location where you wish the text to be transferred.
- 4 Set the iron to cotton 150 to 180°C (302 to 356°F), then press down on the label with the iron for about 15 seconds.
- 5 Allow the iron-on transfer to cool (for about 60 seconds), then carefully remove the backing paper.

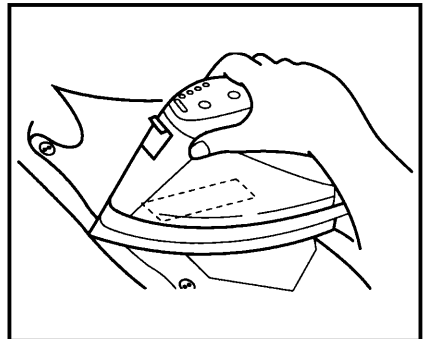
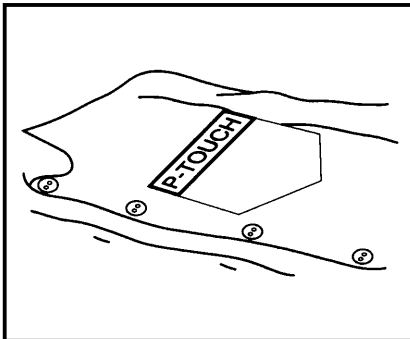

 White garments made from 100% cotton with a plain (smooth) surface are best for making iron-on transfers.

You can also make transfers to garments made from 100% linen or cotton/polyester blends as long as they have a plain (smooth) surface.

The iron-on will not adhere properly to any cloth with a rough surface, such as pile or denim, or with a waterproof surface. Hart- sensitive materials, such as nylon, acetate or other similar fibers, are unsuitable as they may be damaged when they are pressed with an iron at a high temperature.

Press the iron straight down onto the cloth. Do not move the iron while pressing, otherwise the label may move out of place.

After the backing tape has been removed, the transferred iron-on may appear glossy. In addition, some white spots may have appeared on the label if it was touched while the backing tape was peeled off. These can be removed by ironing over the iron-on transfer with a piece of cloth placed between it and the iron.

The iron-on transfer will have a white background on colored cloth.

Since the transferred iron-on cannot be removed once it is applied, make all transfers with care.

## Washing

Garments with iron-on transfers can be washed over 20 times if the iron-on has been transferred correctly. Normal biological and non-biological household detergents may be used. The iron-on may become discolored if the garment is placed in bleach for an extended length of time.

Be careful that hard objects such as buckles or buttons do not come into contact with the iron-on in the wash.

Do not dry clean garments which have had iron-on transfers applied.

## Drying

Garments with iron-on transfers may be dried either inside or outside out.

Do not tumble dry. The transfers will come off and may stick to other items of clothing.

## Ironing

Iron garments with transfers using normal temperature settings.

Be sure to place a piece of cloth between the iron and label when you iron over it to prevent the label from sticking to the iron.

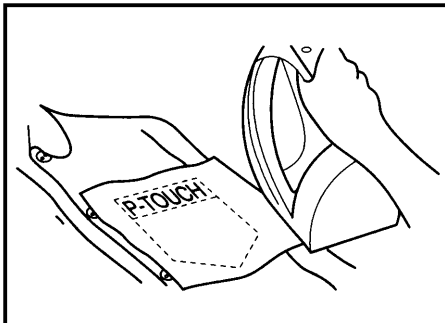

# PRINT HEAD AND ROLLERS

Occasionally, specks of dust or dirt become attached to the machine's print head and rollers. This is particularly likely when you are using the unit outdoors or in a very dusty environment.

**If a section of the print head is covered with dust, a blank horizontal streak may appear through the text in the printed label.**

Therefore, as with a tape recorder, the machine's head may need to be cleaned from time to time.

## TO CLEAN THE PRINT HEAD

- 1 Turn off the machine.
- 2 Open the tape compartment cover, then remove the tape cassette if one is installed. The print head and rollers are located in the tape compartment.
- 3 **Print head:** Use a dry cotton swab to gently wipe the print head with an up-and - down motion.

**Rollers:** Use a dry cotton swab to wipe each roller with an up-and-down motion while rotating them with your finger.

- 4 Try printing again.

If dust still remains:

- 5 Repeat step 3 using a cotton swab dipped in isopropyl (rubbing) alcohol.

If none of the above works, contact your service representative.

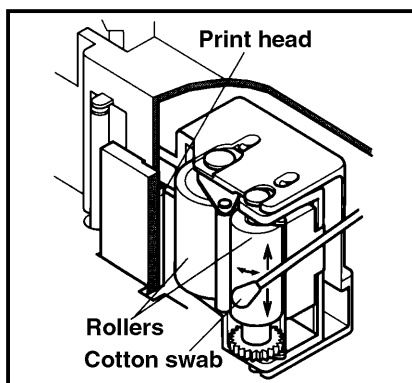
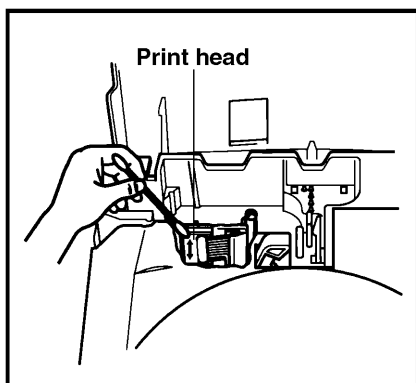





*Learning  
the Ropes*

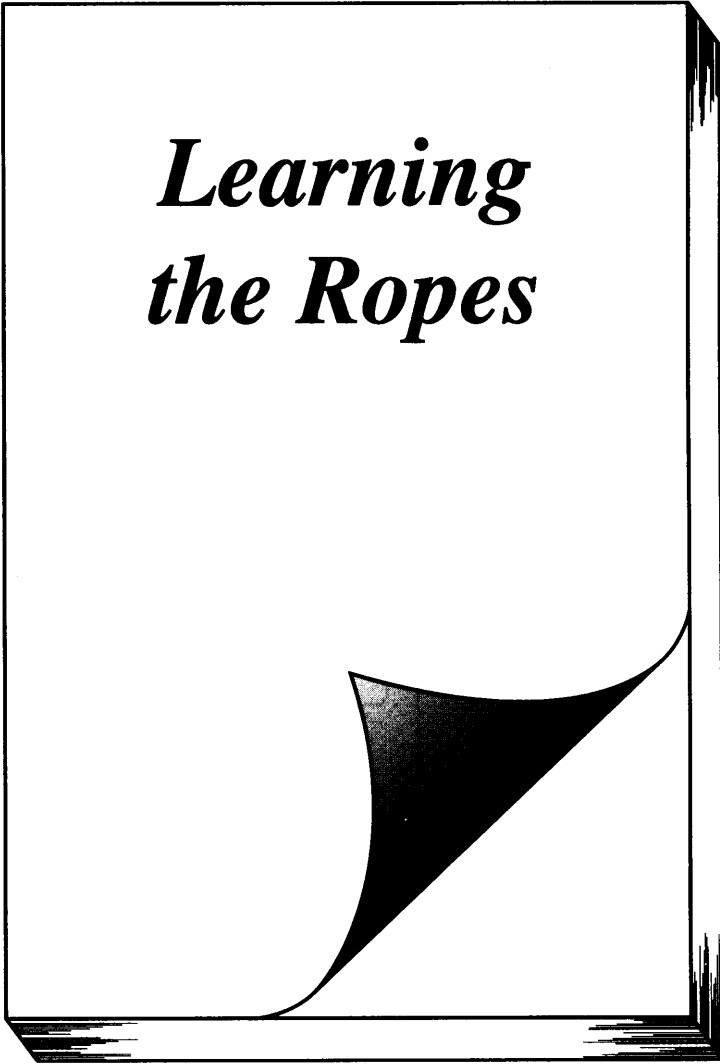



# INTRODUCTION

In *Learning the Ropes*, you will find a series of label-making examples. As the example labels become increasingly more complex, you will learn how to use the more advanced features of the machine. The first exercise consists of creating a simple one-line name tag. The second, an equipment instruction label, takes advantage of several additional machine capabilities. The third is a four-line address label. Finally, the storage shelf label shows you how to use the unit's more expert functions.

If you are a first-time user, we suggest that you work through these exercises to become acquainted with the various features of this machine. Since they do not require much time, they can be done in four separate practice sessions or all at once.

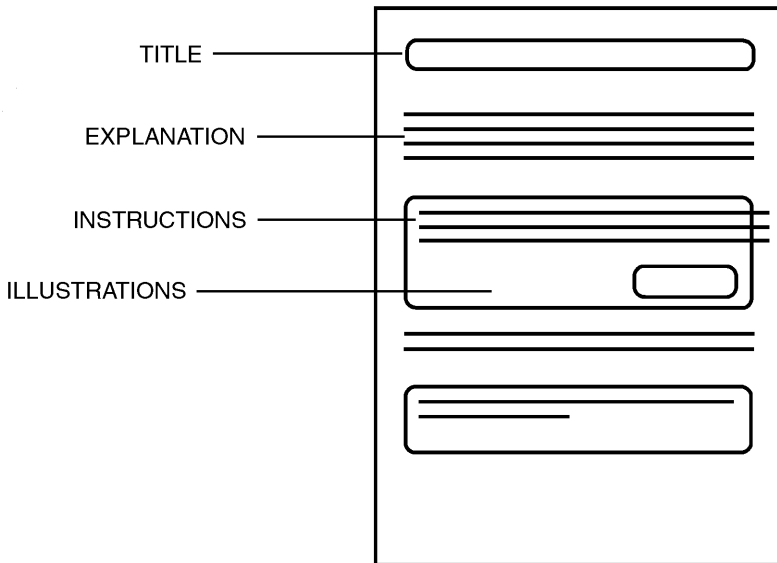
The *Learning the Ropes* examples is constructed as shown below:



 Although the P-touch 530 display is shown in the examples, the operation does not change for the P-touch 550.

To best use this training section, simply follow the flow of the practice sessions. Read the background explanations, then follow the instructions, checking that your results match the illustrations provided. If you would like more detailed information about a particular point, simply check in the *For Your Information* chapter.

Now, let's see how easy it is to make beautiful labels with the P-touch 530/550!

# NAME TAG EXAMPLE



After you have inserted the batteries and the enclosed tape cassette as explained in the *Before You Start* chapter, we can practice using some of the basic functions of your P-touch 530/550. We must first begin by turning on the power to the machine.

## To turn on the machine:

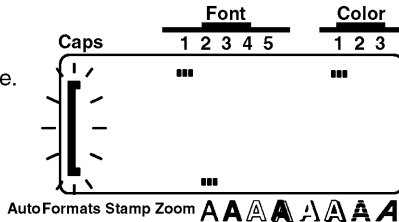
- 1 Press  in the top right-hand corner of the keyboard. When this machine is first turned on, its display is in WYSIWYG mode.



The WYSIWYG (what-you-see-is-what-you-get) mode allows you to see exactly how the label would appear if it were printed. The flashing bracket that appears on the display is called the “cursor”. Its is like a pointer which shows your current position and lets you select characters in your text.

The text you create may sometimes be longer then what this machine's LCD can display at one time. Therefore, the cursor must be moved to show the other parts of the text. Pressing the left cursor key () moves the cursor to the left so that the part of the text on the left side can be seen; pressing the right cursor key () moves the cursor so that the part of the text on the right side canbe seen.

Some format settings are indicated by the rectangles which appear at the top and bottom of the display. The default settings (the settings when the machines is turned on for the very first time) have been pre-programmed into the machine and represent the most common settings for labels. However, you can design your own label to have any format that you wish. Detailed explanations of the formats can be found on page 97 to 120 of *For Your Information*.

Your P-touch 530/550 is also equipped with an Auto Formats function, which allows you to make labels more quickly and easily then if you formatted the text yourself. With this function, simply, select from the many preset label templates that are available and enter the text to create labels which are already formatted with certain fonts, styles and other layout settings. For more details on this function, refer to the *Auto Formats KEY* section on pages 88 to 96.

In this first example, we will use the most basic functions of your P-touch to print simple name tag shown below.



 The label in this example was made using a 1/2" (12-mm)-wide tape cassette.

## ENTER THE TEXT

For this label, we will begin by typing "JOHN SMITH", then later we will edit the text and change its format. Typing on the P-touch is just like typing on a typewriter or a computer. Since, at first, we want all of the text to be in capital letters, we will use the **Caps** mode, which Allows us to enter many capital letters quickly. The **Caps** indication in the top left-hand corner of the display lights up when the machine is in **Caps** mode.

### To enter Caps mode:

- ② Hold down  and press  until the **Caps** indicator lights up.

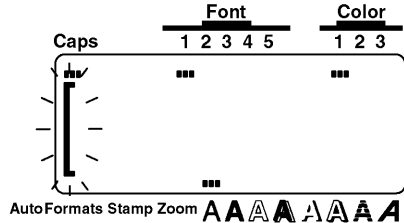



Now, we can type in the first name.

### To type in the text "JOHN":

- ③ Press , , , and then  once each.

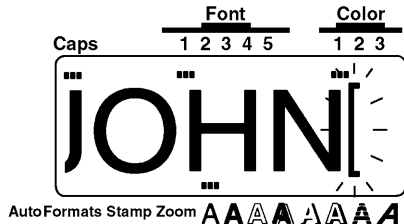
 In **Caps** mode, all letters are automatically entered as capital letters.



Also like on a typewriter or computer keyboard, the **Space** key (  ) allows you to add blank spaces to the text.



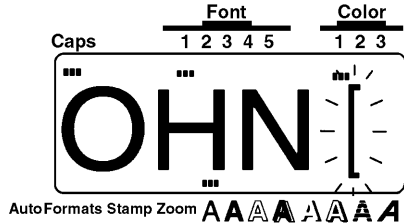

**To add a space:**

④ Press  once.



Then, type the last name (SMITH) to finish entering the text.

**To type in "SMITH":**

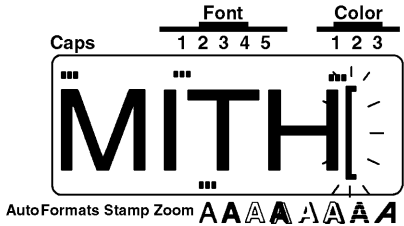

⑤ Press , , , , and then  once each.

*Whenever the entered text is longer than what can fit in the LCD display, part of it will move off the end of the display and can only be seen by moving the cursor.*



Now that we are finished entering capital letters, we can exit **Caps** mode.



**To exit Caps mode:**

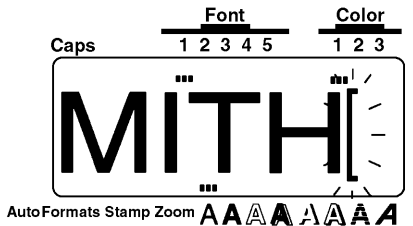

⑥ Hold down  and press  until the **Caps** indicator goes off.



## EDITING THE TEXT

Once you have entered the text, you can easily edit it to change or correct it. For detailed explanations of the text editing keys and functions, refer to pages 71 through 73.

The backspace key (  ) allows you to erase characters from your text. Pressing  once deletes the characters immediately to the left of the cursor's current position and moves the characters after the deleted character one space to the left.



 The difference between the backspace key (  ) and the left cursor key (  ) is that the left cursor key only moves the cursor without changing the text.

**To change "SMITH" to "Smith" :**

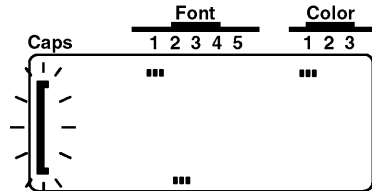
7 Press  four times until "MITH" is erased.



AutoFormats Stamp Zoom      

8 Press , , , and then  once each.

 Since the machine is no longer in **Caps** mode, all letters are entered in lower-case.

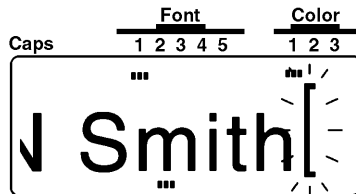

AutoFormats Stamp Zoom      

**To change "JOHN" to "John" :**



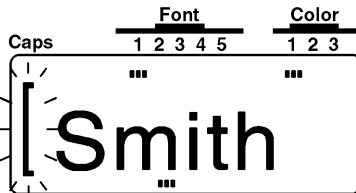



9 Press  until the cursor is to the right of "N".

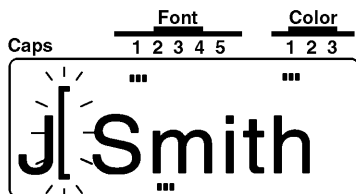



AutoFormats Stamp Zoom      

10 Press  three times until "OHN" is erased.



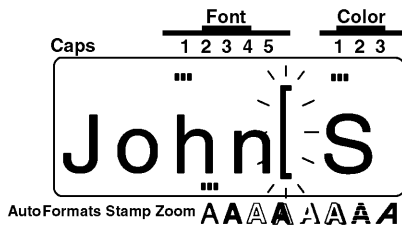

AutoFormats Stamp Zoom      

11 Press , , and then  once each.





## FORMATTING THE TEXT

Using the text format keys below the display (, , etc.), the text format setting can be changed either before or after the text is entered. If the text that we entered were printed now, the default text format settings would be used (Font1, medium width, A [normal] style, AUTO size, no underlining/framing and printed in COLOR 1). For more details on the text formats, refer to pages 97 through 109.

For this example, though, let's decorate our label by changing the font of the text. If we would want to change the font of just a part of the text, we would use the **Area** and cursor keys to select the part of it. However, since we want to change the font for all of the text, we will use the **All** function to select all of it. Then, we can use  to select the desired font.

### To change the font of all of the text:

12 Hold down  and press .

 With the **All** function, all of the text is automatically highlighted.

13 Press  until the **Font** indicator appears below Font2.

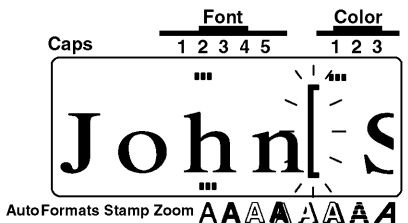
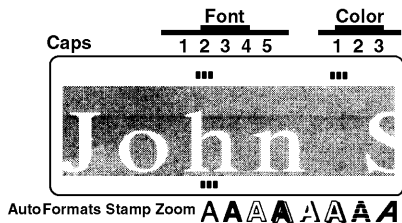
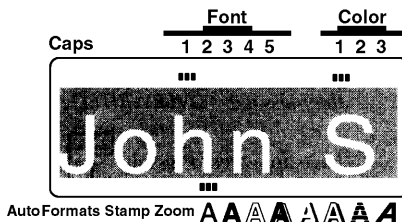

14 Press .





## STORING THE TEXT



Next, let's look at how to store text files so that they can be recalled later and either edited or printed. Detailed explanation of the machine's memory can be found in *Store, Recall AND M.Del KEYS* on pages 134 to 138.

### To start the text as file number 1:

15 Hold down  and press .

16 Press  or  until the number 1 is displayed.

17 Press . The text is stored as file 1 and can be recalled at any time.

*If text had already been stored as file 1, the message "OVERWRITE?" would have appeared. Pressing  would then erase the old file and save the new one as file 1. Otherwise  should be pressed to stop the operation.*

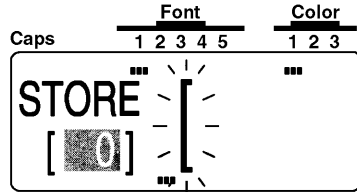

AutoFormats Stamp Zoom 

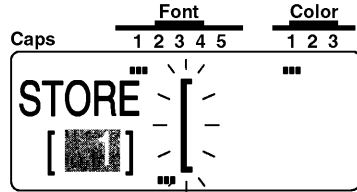

AutoFormats Stamp Zoom 

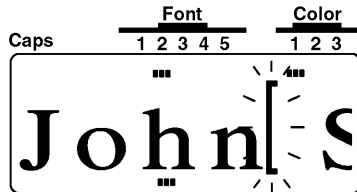

AutoFormats Stamp Zoom 

When text is stored in the memory, all of its format settings are also stored with it. Therefore when the text file is recalled, the format settings for the stored text file are also recalled.



# PRINT THE TEXT

Since our text is finished, we can print it. If we used the default settings pre-programmed into the P-touch for the **Special Print** function, we could print one whole copy of the label, which would automatically be cut after printing is finished.

**To print one copy of the label:**

13 Press  .

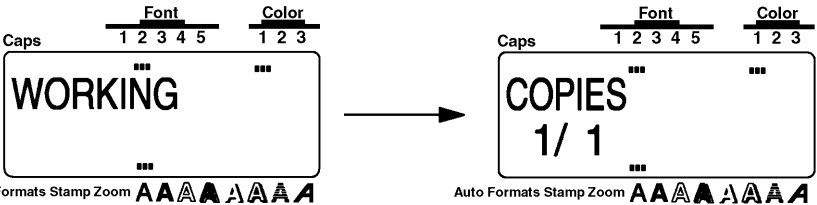

The diagram illustrates the process of printing a label. It shows two stages of a label's state. On the left, a label displays the word "WORKING". Above the text, there are two sets of settings: "Font" with options 1, 2, 3, 4, 5 and "Color" with options 1, 2, 3. To the left of the text is a "Caps" indicator, and to the right are three dots. Below the label is the text "Auto Formats Stamp Zoom" followed by five stylized 'A' icons of varying sizes. An arrow points to the right, where the label now displays "COPIES" on the top line and "1/ 1" on the bottom line. The settings and indicators above and below the label are identical to the first stage.

# EQUIPMENT LABEL EXAMPLE

Now that we know how to enter, edit and print text, we can practice creating a multi-line label. In this example, we will also learn how to use the **Special Print** and the **Format** key functions to print three copies of the copier label shown below.



 The label in this example was made using a 1/2" (12-mm)-wide tape cassette.

## CLEARING THE DISPLAY

Before entering our new text, we must first erase the text that is shown in the display from the previous time that the machine was used. When we clear the display, all of the text formats (font, size, width, style, underline/framing and color) and the **Format** key functions return to their default settings.

To clear the display for a new label:

1 Hold down  and press  .

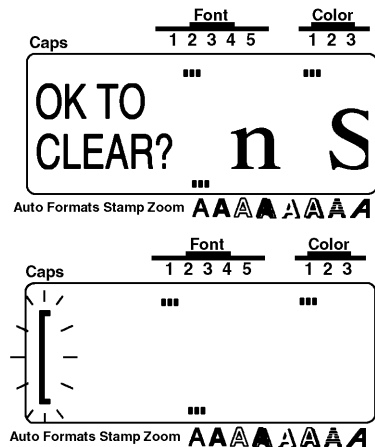

2 Press  .



## ENTERING THE TEXT

This time, since we don't want all of the text to be in capital letters, we will enter the capital letters in the text while holding down . The **Caps** indicator in the top left-hand corner of the display lights up when the machine is in **Caps** mode.

To type in "Place original face down." :

3 Hold down  and press , then release .

4 Type "lace original face down" .

5 Press .

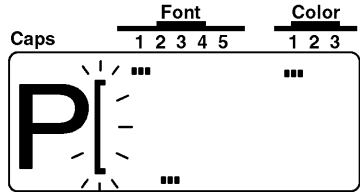

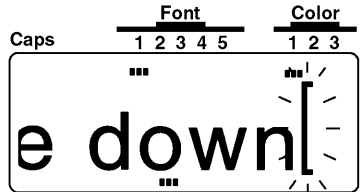

AutoFormats Stamp Zoom 

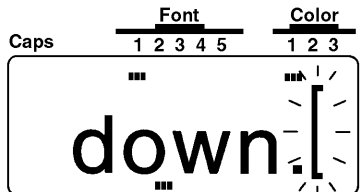

AutoFormats Stamp Zoom 





AutoFormat Stamp Zoom 

In a multi-line label, the return key () can be used to end one line and start the next one.

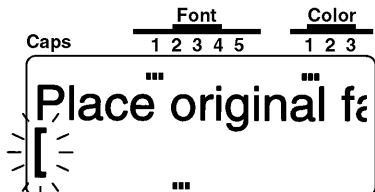

To type in the second and third lines:

6 Press  to move the cursor to the next line.





Auto Format Stamp Zoom 

7 Type in "For repairs, call."



*To type in "F", hold down  and press . Since the text is longer than the LCD display, the first characters of the two lines move off the display to the left.*

8 Press  to move the cursor to the text line.

9 Type in "Service Dept.:"

*To type in ":", hold down  and press .*

10 Press , then type in "123-4567".

*To type in "-", hold down  and press .*

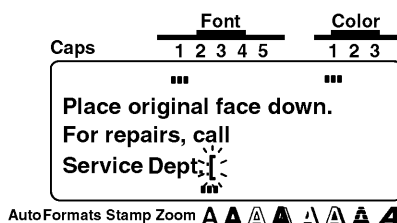
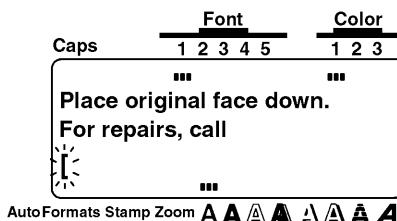
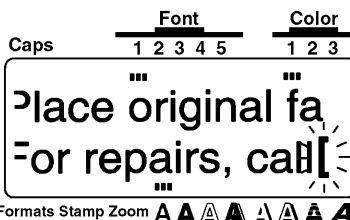

## FORMATTING THE TEXT

Since our text is entered as we wish, we can begin changing its format to put a frame around the text and align each text line in the center. Pressing the **Format** key () allows you to view the current label formats. These settings can only be applied to the entire text. For detailed explanations of the label format functions, refer to pages 110 through 121 of For Your Information.

*If you wish to leave all of the label format settings unchanged and return to the text, press . A detailed explanation of the **Cancel** key can be found on pages 68 to 70 of For Your Information.*

For this label, though, let's assume we want to put a frame around all of the text and center it horizontally. Therefore, we must press **Format** and change the GLOBAL FRAME and H.ALI (horizontal alignment) function settings.

**To change the label formats:**

- 11 Press **Format**.
  - ☛ The OFF setting of GLOBAL FRAME is highlighted. The highlighting is like a cursor. It shows which function can be changed; items can only be changed when their setting is highlighted.

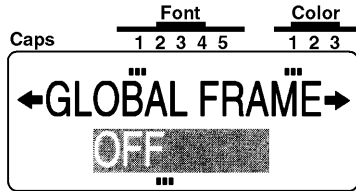

AutoFormats Stamp Zoom **A A A A A A A A**

- 12 Press **Home** or **End** until the box setting ( ) is selected for the GLOBAL FRAME function.

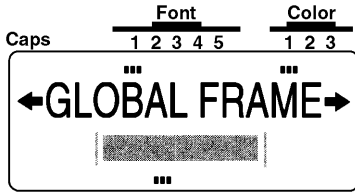

AutoFormats Stamp Zoom **A A A A A A A A**

- 13 Press **Left** or **Right** until the highlight is immediately under the H.ALI (horizontal alignment) function.

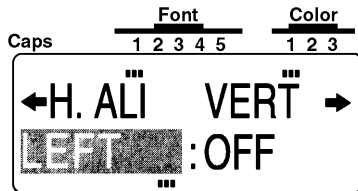

AutoFormats Stamp Zoom **A A A A A A A A**

- 14 Press **Home** or **End** until the CENTER setting is selected.

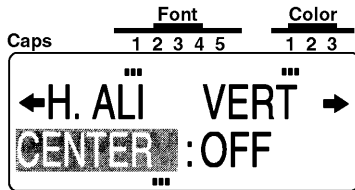

AutoFormats Stamp Zoom **A A A A A A A A**

- 15 Press **New Block**.

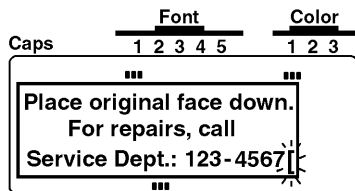

AutoFormats Stamp Zoom **A A A A A A A A**

# PRINT THE TEXT

Suppose we wish to print three copies this label. To do this, we would use the COPIES parameter of the **Special Print** function. For more details on the **Special Print** function parameters, refer to pages 128 and 129.

## To print three copies of the label:

16 Hold down  and press .

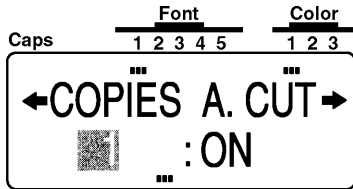

AutoFormats Stamp Zoom **A A A A A A A**

17 Press  or  until the COPIES parameter is set to 3.

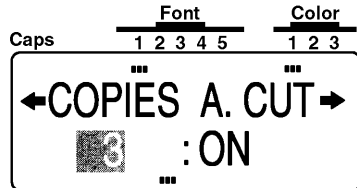

AutoFormats Stamp Zoom **A A A A A A A**

18 Press . Three copies of the copier label are printed and cut off.

*Since you may not want to use too much tape for an example, you can press  to quit printing and return to WYSIWYG mode. However, the COPIES parameter will remain set to 3.*

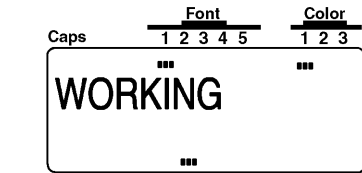

Auto Formats Stamp Zoom **A A A A A A A**

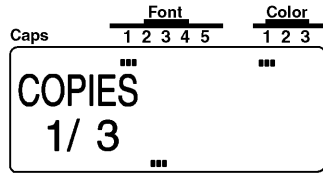

Auto Formats Stamp Zoom **A A A A A A A**

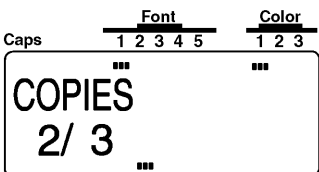

Auto Formats Stamp Zoom **A A A A A A A**

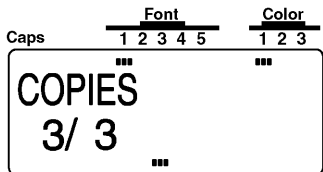

Auto Formats Stamp Zoom **A A A A A A A**

Place original face down.  
For repairs, call  
Service Dept.: 123-4567

Place original face down.  
For repairs, call  
Service Dept.: 123-4567

Place original face down.  
For repairs, call  
Service Dept.: 123-4567

 If the *A.CUT* parameter of the **Special Print** function was set to *OFF*, the three labels would be printed together. To make three separate labels, use scissors to cut them apart.

Place original face down.  
For repairs, call  
Service Dept.: 123-4567

Place original face down.  
For repairs, call  
Service Dept.: 123-4567

Place original face down.  
For repairs, call  
Service Dept.: 123-4567

# ADDRESS LABEL EXAMPLE

In this example, we will recall our name tag text file, change it into a multi-line address label, then print using the color printing functions. We will also use some of the other text format keys to emphasize part of the text.







 The label in this example can be printed on 3/4"(18-mm)-, 1"(24-mm)- or 1-1/2" (36mm)-wide tape.

## RECALLING TEXT

Since we saved the name tag text in the memory, we can recall it to edit it. If we had not saved the text, it would be lost and we would have to type it in again. When we recall text from the memory, any text that was shown in the display is deleted.

### To recall the name tag text file:

1 Hold down  and press .

 Since file 1 is the last file that was used, it is the one that is displayed. Otherwise we would need to press  or  to select our desired files.

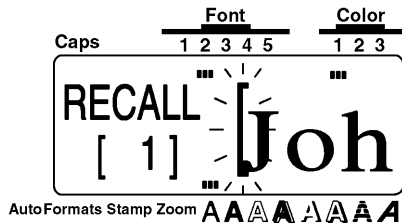

2 Press .

 Before the recalled text is displayed, any text that was in the display from the previous time that the machine was used is erased.

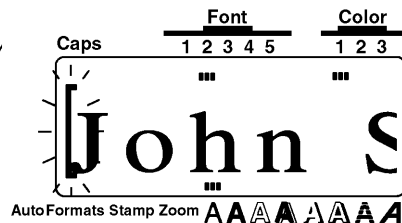



## ENTERING THE TEXT

Now, we can type in the address and telephone number for our label.

### To type in the address:

3 Hold down **Code** and press **▶▶**.

4 Press **New Block**.

5 Type "29 South Main St." and press **New Block**.

6 Type "Los Angeles, CA 88888" and press **New Block**.

### To add the telephone symbol (☎):

7 Hold down **Code** and press **Symbol**.

8 Press **Home** or **End** until the row containing the telephone symbol is displayed.

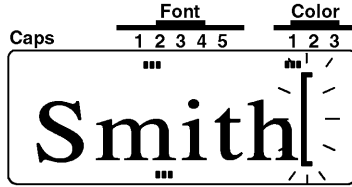

AutoFormats Stamp Zoom **AAA** **AAA** **AAA** **AAA**



AutoFormats Stamp Zoom **AAA** **AAA** **AAA** **AAA**

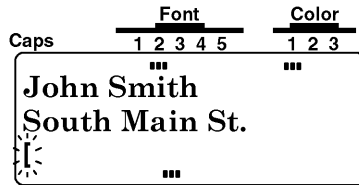

AutoFormats Stamp Zoom **AAA** **AAA** **AAA** **AAA**

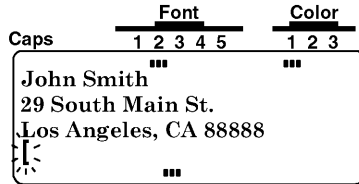

AutoFormats Stamp Zoom **AAA** **AAA** **AAA** **AAA**

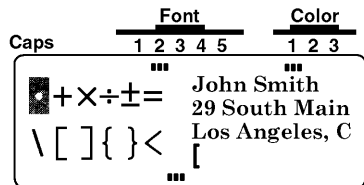

AutoFormats Stamp Zoom **AAA** **AAA** **AAA** **AAA**

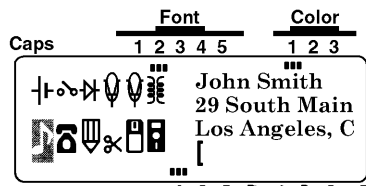

AutoFormats Stamp Zoom **AAA** **AAA** **AAA** **AAA**

9 Press or until "a" is highlighted.

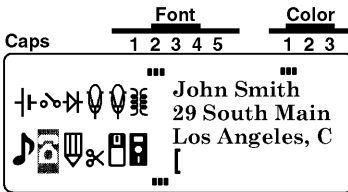

10 Press .

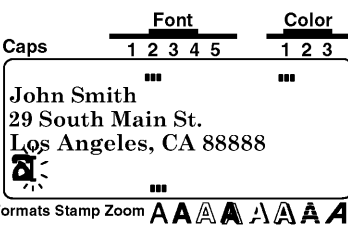

Since the text is displayed in the WYSIWYG mode, it starts to become small and difficult to read when too many lines are entered. Therefore, we will use the zoom function so that we can see the text more clearly.

**To zoom in on the text:**

11 Press once.

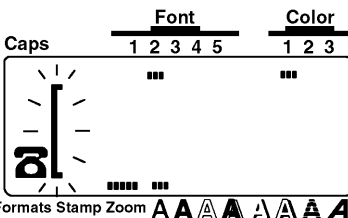

12 Press , then type in "012-345-6789".

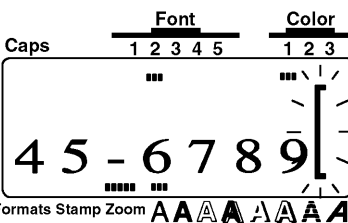

**To zoom out from the text:**

- 13 Press **Zoom** twice (or press just **Cancel**) to return to WYSIWYG mode.

	Font					Color		
Caps	1	2	3	4	5	1	2	3
John Smith	***					***		
29 South Main St.								
Los Angeles, CA 88888								
012-345-6789								

AutoFormats Stamp Zoom **A A A A A A A A**

**FORMATTING THE TEXT**

We have already practiced changing the text format for the entire text with the **All** function. However, with the **Area** key (**Area All**) and the cursor keys, you can select just a part of the text, and then change just its format. We will use this key to change the style of the name in our address label. For more details, refer to pages 97 through 109.

**To select the name:**

- 14 Press **Home** and **Left** until the cursor is to the left of "J" in the name.

	Font					Color		
Caps	1	2	3	4	5	1	2	3
John Smith	***					***		
29 South Main St.								
Los Angeles, CA 88888								
012-345-6789								

AutoFormats Stamp Zoom **A A A A A A A A**

- 15 Press **Area All**.

*The "J" will be highlighted, showing that it will be included in the selected text.*

	Font					Color		
Caps	1	2	3	4	5	1	2	3
John Smith	***					***		
South Main St.								
Los Angeles, CA 88888								
012-345-6789								



AutoFormats Stamp Zoom **A A A A A A A A**

- 16 Hold down **Code** and press **Right** to highlight "John Smith".









	Font					Color		
Caps	1	2	3	4	5	1	2	3
JOHN SMITH	***					***		
South Main St.								
Los Angeles, CA 88888								
012-345-6789								

AutoFormats Stamp Zoom **A A A A A A A A**









**To change the style of the name:**

17 Press  until the text is displayed in the outline style. (The indicator above  appears.)

18 Press .

	Font					Color		
Caps	1	2	3	4	5	1	2	3
...	...	...	...	...	...	...	...	...
John Smith								
South Main St.								
Los Angeles, CA 88888								
☎ 012-345-6789								
AutoFormats Stamp Zoom        								









	Font					Color		
Caps	1	2	3	4	5	1	2	3
...	...	...	...	...	...	...	...	...
John Smith								
South Main St.								
Los Angeles, CA 88888								
☎ 012-345-6789								
AutoFormats Stamp Zoom        								

The text format settings could also have been chosen before the text was entered. In this way, the selected settings would remain until they are changed again. Next, we can use the **Format** key to add a frame all around our address label text.









**To add a frame around the entire text:**

19 Press .

20 Press  or  until the box setting (  ) is selected.

	Font					Color		
Caps	1	2	3	4	5	1	2	3
...	...	...	...	...	...	...	...	...
←GLOBAL FRAME→								
OFF								
AutoFormats Stamp Zoom        								

  

	Font					Color		
Caps	1	2	3	4	5	1	2	3
...	...	...	...	...	...	...	...	...
←GLOBAL FRAME→								
AutoFormats Stamp Zoom        								

Since we've used the outline style and added a frame to our text, we must set two more functions before we can print with the color printing function. The FRAME COLOR function is used to select the color setting for the frame, underlines and shadings in the text; the STYLE COLOR function is used to choose the color setting for the parts of the characters that are normally left blank when styles other than **A** (normal), **A** (bold), *A* (italic) or **A & A** (italic & bold) are used. For more details on these functions, refer to page 113 through 115.

**To change the FRAME COLOR and STYLE COLOR functions:**

21 Press **←** or **→** until the highlight is immediately under the FRAME COLOR function.

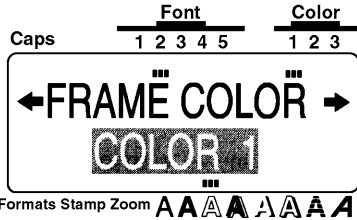

22 Press **Home** or **End** until the COLOR2 setting is selected.

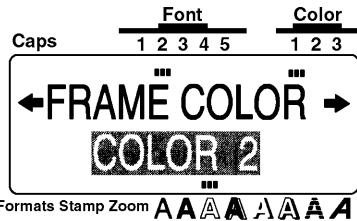

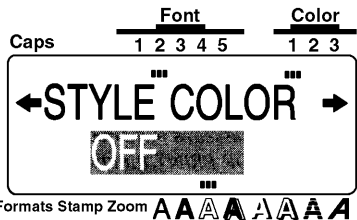

23 Press **←** or **→** until the highlight is immediately under the STYLE COLOR function.

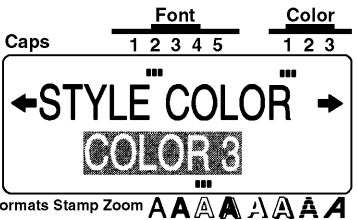

24 Press **Home** or **End** until the COLOR3 setting is selected.



25 Press  .

	Font					Color		
Caps	1	2	3	4	5	1	2	3
	'''					'''		
								
AutoFormats Stamp Zoom 								

## PRINTING THE TEXT

Now, let's assume we wish to print a copy of this label in color. Therefore, we must decide which ink colors will be used for COLOR1, COLOR2 and COLOR3. For this example, let's fill in the name with red (COLOR2) and print the frame in blue (COLOR3). We will print the rest of the text, which has default setting (COLOR1), in black. For more details on color printing, refer to pages 123 to 124.

**To print a copy of the label in color:**





26 Insert a black ink cassette into a color printing tape cassette, then open the tape compartment cover and install the cassettes.

27 Press  to align the tape end with the edge of the tape cassette.

28 Press  .

*Since more than two color settings have been selected and color printing ink and tape cassettes have been installed, the COLOR PRINT function is automatically turned on when  is pressed.*

29 Press  .

	Font					Color		
Caps	1	2	3	4	5	1	2	3
	'''					'''		
								
AutoFormats Stamp Zoom 								
	Font					Color		
Caps	1	2	3	4	5	1	2	3
	'''					'''		
								
AutoFormats Stamp Zoom 								

- 30 Make sure that the black ink cassette is installed in the tape compartment and that the cover is closed, then press .

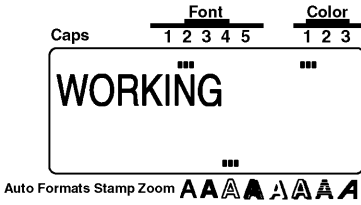

Auto Formats Stamp Zoom **A A A A A A**

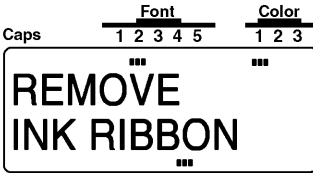

Auto Formats Stamp Zoom **A A A A A A**

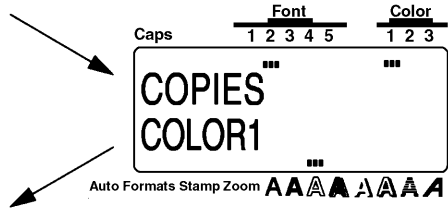

Auto Formats Stamp Zoom **A A A A A A**

- 31 Open the tape compartment and remove the black ink cassette, press . Rewind the tape roll using your finger to turn it anti-clockwise until the tape and aligns with the tape cutter.

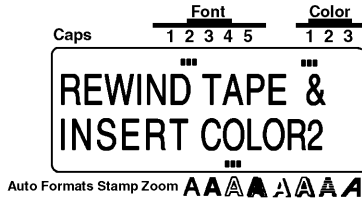

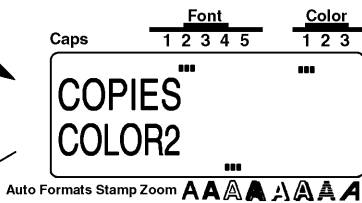
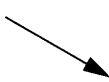
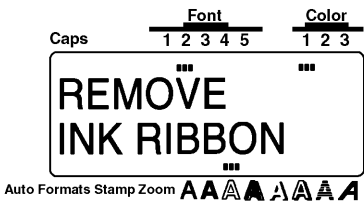
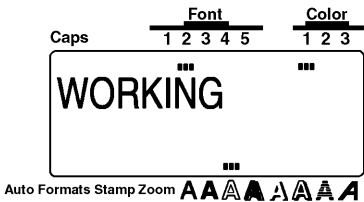

Auto Formats Stamp Zoom **A A A A A A**

- 32 Install the red ink cassette, then close the tape compartment and press .

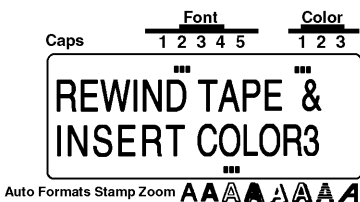

- 33 Open the tape compartment and remove the red ink cassette, press . Rewind the tape roll using your finger to turn it clockwise until the tape end aligns with the tape cutter.



- 34 Install the blue ink cassette, then close the tape compartment and press .

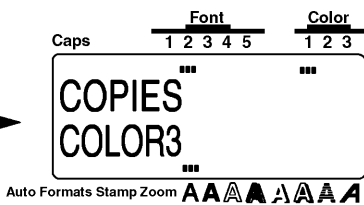
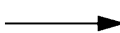
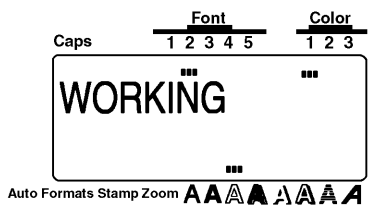

- 35 After the label is cut off, use scissors to cut along the two printed dots to make equal margins.





# STORAGE SHELF LABEL EXAMPLE

In this final example, we will practice using the **New Block** function as well as more specialized features, such as the Barcode and **Seq. Numbering** (sequential numbering) functions, in order to make the following two labels which could be used to describe objects stored on a shelf.

<b>B1</b>	Supplier AXZ Corp. Main St. Fairtown, CA 88888	<b>IN: 98/1/28 - OUT: 98/2/28</b> 
-----------	---	--

<b>B2</b>	Supplier AXZ Corp. Main St. Fairtown, CA 88888	<b>IN: 98/1/28 - OUT: 98/2/28</b> 
-----------	---	--

 The label in this example can be printed on 3/4"(18-mm)-, 1"(24-mm)- or 1-1/2" (36-mm)-wide tape.

Each time the number of lines changes, a new block of text must be created. Therefore, the text for our label must be entered in three separate blocks as shown below. With the WYSIWYG mode, making complex multi-block labels is easier since you can see exactly how the label would appear if it were printed.

<b>B1</b>	Supplier AXZ Corp. MainSt. Fairtown, CA 88888	<b>IN: 98/1/28 - OUT: 98/2/28</b> 
BLOCK 1	BLOCK 2	BLOCK 3

## CLEARING THE DISPLAY

Again, we must first erase the text that is shown in the display from the previous time that the machine was used.

To Clear the display for a new label:

1 Hold down  and press .

2 Press .

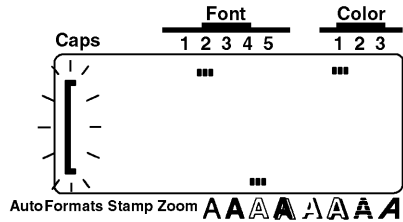
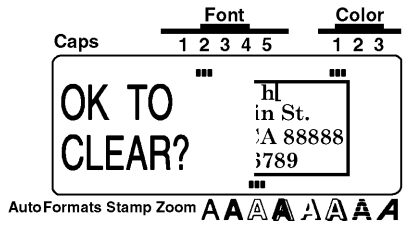

## ENTERING THE TEXT

Now, we can begin entering the storage shelf label text. Since we know that we want to use a different font for the first block, we can select the new font before entering the text.

To type in the first block of text using Font 2:

3 Press  until the **Font** indicator appears below Font 2.

4 Type in "B1".

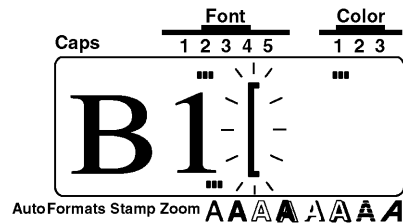
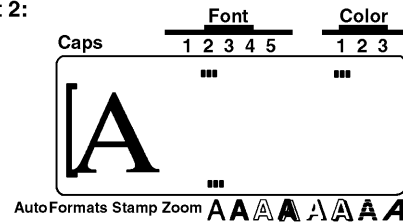

Since we now want to change from a one-line to a four-line block, we will use the **New Block** function. A detailed explanation of multi-block labeling can be found in *New Block FUNCTION* on pages 66 and 67.

**To type in the second block of text:**

⑤ Hold down  and press .

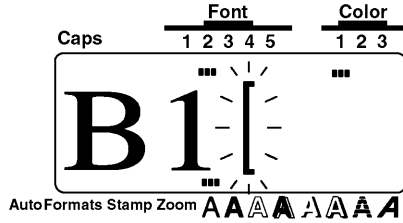

⑥ Press  until the **Font** indicator appears below Font 1.

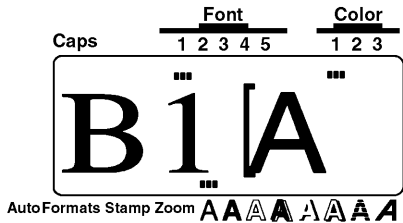

⑦ Type in "Supplier:", "AXZ Corp." and "Main St.", pressing  after each line.

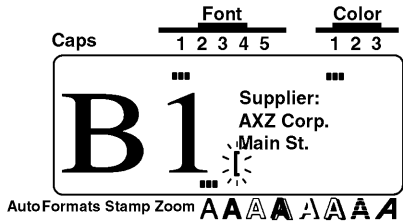

**To zoom in on the text and type in the last line:**

⑧ Press  once.

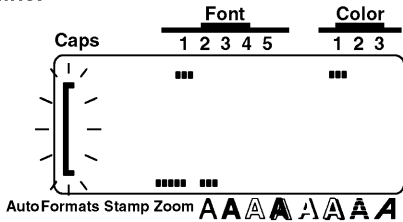

9 Press **Zoom** twice (or press just **Cancel**) to return to WYSIWYG mode.

10 Type in "Fairtown, CA 88888".

11 Hold down **Code** and press **New Block**.

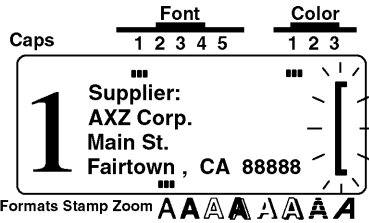
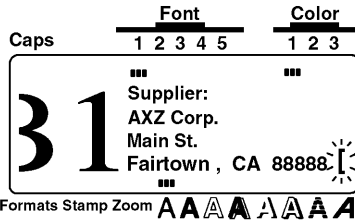

To try in the third block of text:

12 Type "IN: 98/1/28 - OUT: 98/2/28" and press **New Block**.

The cursor will move to the second line and the last characters of the line will move off the display.

To move the cursor quickly from block to block, hold down **Shift** and press **←** or **→**.

A detailed explanation of these operations can be found in CURSOR KEYS on pages 57 and 58.

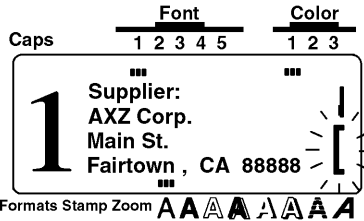

Now, we must enter the last part of the text, the bar code. Although there are many settings for bar codes, let's use protocol CODE 39, which has an unspecified (free) number of digits. More details on the **Barcode** function can be found on pages 80 to 84.

### To add a bar code:

13 Hold down **Code** and press **Barcode**.

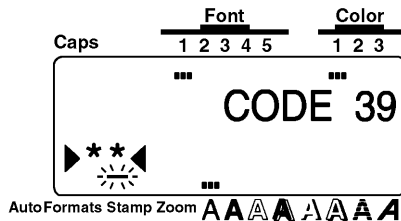

If we wished to use a different protocol or change any of the default bar code settings, we could press **Format** and use the cursor keys to change the parameter settings. However, since we will use the default settings for this example, we can immediately input our bar code data.

### To enter the bar code data:

14 Type in "1584724".

15 Press **New Block**.

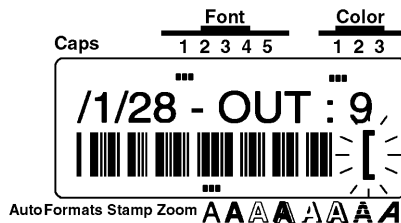
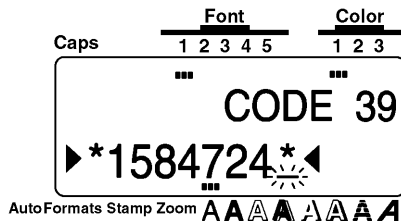

## PRINTING THE TEXT

Finally, let's assume that we want to put labels on two different shelves (B1 and B2) while keeping the same bar code. To do this, we can use the **Seq. Numbering** (sequential numbering) function to print two copies of our label while automatically increasing the shelf number after each label is printed. More details can be found in *Seq. Numbering FUNCTION* on pages 130 to 133.

**To print using the Seq. Numbering function:**

- 16 Press and until the cursor is to the left of "1".

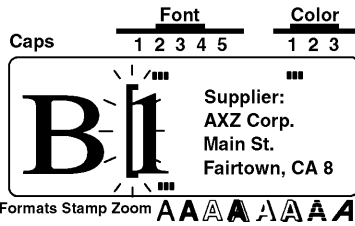

- 17 Hold down and press .

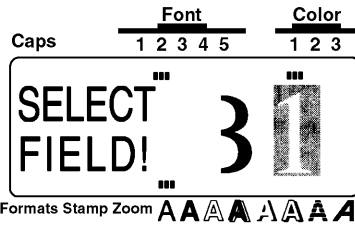

- 18 Since we only want "1" in the numbering field, press .

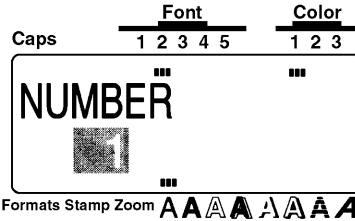

- 19 Press or until the NUMBER setting is set to 2.

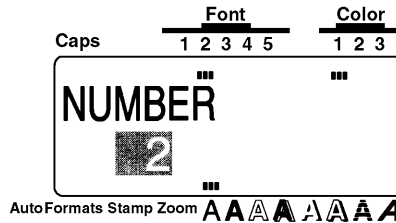



	Font					Color		
Caps	1	2	3	4	5	1	2	3
WORKING								

Auto Formats Stamp Zoom **A A A A A A A A**

	Font					Color		
Caps	1	2	3	4	5	1	2	3
WORKING								

Auto Formats Stamp Zoom **A A A A A A A A**

	Font					Color		
Caps	1	2	3	4	5	1	2	3
<b>B3</b> Supplier: AXZ Corp. Main St. Fairtown, CA 88								

Auto Formats Stamp Zoom **A A A A A A A A**



	Font					Color		
Caps	1	2	3	4	5	1	2	3
COPIES 1 / 2								

Auto Formats Stamp Zoom **A A A A A A A A**



	Font					Color		
Caps	1	2	3	4	5	1	2	3
COPIES 2 / 2								

Auto Formats Stamp Zoom **A A A A A A A A**

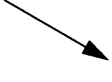

<b>B1</b>	Supplier: AXZ Corp. Main St. Fairtown, CA 88888	<b>IN: 98/1/28 - OUT: 98/2/28</b> 1 1000000 1000000 1000000 1000000 1000000 1000000 1000000 1000000 1000000 *1587472*
-----------	--	---

<b>B2</b>	Supplier: AXZ Corp. Main St. Fairtown, CA 88888	<b>IN: 98/1/28 - OUT: 98/2/28</b> 1 1000000 1000000 1000000 1000000 1000000 1000000 1000000 1000000 1000000 *1587472*
-----------	--	---

With these four examples, we have covered most of the basic features of your P-touch 530/550 so that you can begin creating your own customized labels. If you have questions about any of the functions, refer to the appropriate explanation in the *For Your Information* chapter.





*For Your  
Information*

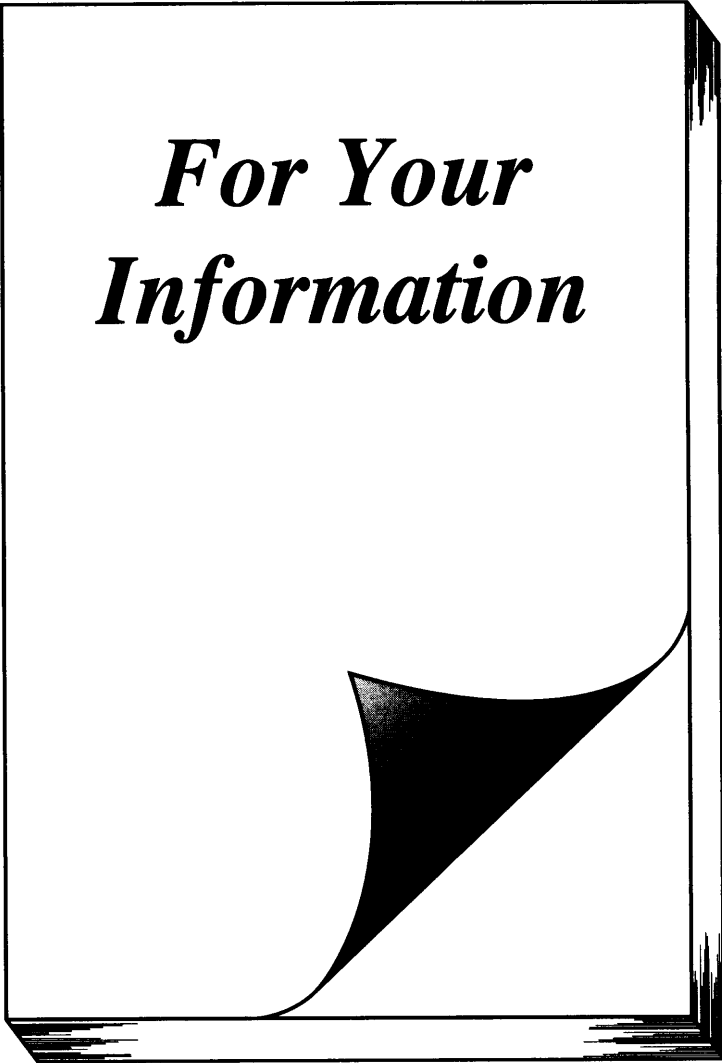

# INTRODUCTION

In this chapter, you will find detailed explanations for all of the machine's features. Each topic is given its own section, making this reference chapter easy to use.



Operational examples of most features can also be found in the *Learning the Ropes* practice sessions. If you are a first-time P-touch user, we suggest that you work through those exercises before starting to make labels on your own.

This *For Your Information* chapter provides supplementary information. When you have a question about a particular key or function, locate that topic in the *FINDING YOUR WAY* contents list and turn to the page indicated.

 *Although the P-touch 530 display is shown in the examples, the operation does not change for the P-touch 550.*

# FINDING YOUR WAY

This *For Your Information* chapter gives detailed explanations of all of this machine's features. The following list shows which topics are covered and on which page an explanation of their operation can be found.

	PAGE		PAGE
<b>On/Off</b> key	56	<b>Format</b> key	110
<b>INPUTTING AND EDITING</b>		Label Formats:	
Cursor key	57	GROBAL FRAME function	112
<b>Code/Alt/Shift</b> keys		FRAME COLOR function	113
and <b>Caps</b> mode	59	STYLE COLOR function	114
<b>Space</b> key	62	LENGTH function	116
 (return) key		FEED (tape feed) function	117
<b>New Block</b> function	66	H.ALI (horizontal	
<b>Cancel</b> key	68	alignment) function	118
<b>BS</b> (backspace) key	71	VERT (vertical printing) function	119
<b>Line Out</b> function	72	MIRROR (mirror printing)	
<b>Clear</b> function	73	function	120
<b>Symbol</b> function	75	UNIT function	121
<b>Accent</b> function	78		
<b>Barcode</b> function	80	<b>PRINTING</b>	
		<b>Print</b> key and <b>Feed &amp;</b>	
<b>DISPLAYING</b>		 (tape cut) key	
<b>Zoom</b> key	85	COLOR PRINT function	123
<b>Contrast</b> function	86	<b>Stamp</b> function	125
<b>Label Length</b> function	87	<b>Special</b> Print function	128
<b>FORMATTING</b>		<b>Seq. Numbering</b>	
<b>Auto Format</b> key	88	(sequential numbering) function	130
<b>Area</b> key and <b>All</b> function	97		
Text Formats:		<b>MEMORY FUNCTIONS</b>	
<b>Font</b> key	100	<b>Store, Recall</b> and <b>M.Del</b> keys	134
<b>Size</b> and <b>Width</b> keys	102		
<b>Style</b> key	104		
<b>Undl/Frm</b> (underline/frame) key	107		
<b>Color</b> key	109		

# On/Off KEY

## BACKGROUND



The On/Off key () is located in the top right-hand corner of the machine's keyboard. If batteries have been installed or the machine has been plugged in using the optional AC adaptor, the previous session's information is displayed when the machine is turned on. This feature allows you to stop work on a label, turn off the machine, and return to it later without having to re-enter the text.

 *When changing the batteries, be sure to insert the new ones within five minutes of removing the old batteries, otherwise the text shown in the display and any text files stored in the memory will be lost (unless the machine is plugged into an AC outlet with the AC adaptor).*

*If the adaptor is removed from the AC outlet before unplugging it from the machine, the text files in the memory will not be deleted if batteries are correctly installed.*





The machine will automatically turn off if no key is pressed within 5 minutes. The machine's Internal memory stores the current session's information and displays it when you turn on the machine again.

## OPERATION

- To turn on the machine, press . The previous session's information appears on the LCD display.
- To turn off the machine, press . The current session's information is stored in the internal memory.





# CURSOR KEY

## BACKGROUND





The four cursor keys (  ,  ,  and  ) can be used to perform two different operations: to move the cursor and make a selection. The cursor, which appears as either a bracket ( `[` ) or an underline ( `_` ), can be moved using the cursor keys to any point in your text so that you can display or edit it. To make a selection, use the cursor keys to move the highlight or flashing highlight over the characters or setting that you want to choose.

## OPERATION



### LEFT CURSOR KEY

- To move the cursor one space or character to the left, press  once. If the cursor is positioned at the beginning of a line when this key is pressed, the cursor moves to the end of the previous line.
- To move the cursor to the beginning of the current line of text, hold down  and press .
- To move the cursor to the beginning of the current text block, hold down  and press . If the cursor is already positioned at the beginning of a text block when these keys are pressed, the cursor moves to the beginning of the previous block.



### RIGHT CURSOR KEY

- To move the cursor one space or character to the right, press  once. If the cursor is positioned at the end of a line when this key is pressed, the cursor moves to the beginning of the text line.
- To move the cursor to the end of the current line of the text, hold down  and press .
- To move the cursor to the beginning of the next text block, hold down  and press .

## UP CURSOR KEY

- To move the cursor to the character in the line directly above the cursor's current position, press  once.
- To move the cursor to the beginning of the entire text, hold down  and press .

## DOWN CURSOR KEY

- To move the cursor to the character in the line directly below the cursor's position, press  once.
- To move the cursor to the end of the entire text, hold down  and press .

# Code/Alt/Shift KEYS AND Caps MODE

## BACKGROUND

Most characters can be entered simply by pressing their keys. However, to use special functions or to enter capital letters, accented characters and some symbols, the following special keys are necessary.



## Code KEY

## OPERATION

- To use a function printed in yellow (P-touch 530) or pink (P-touch 550) above a key, hold down  and press the key for the function that you wish to use.

## EXAMPLE



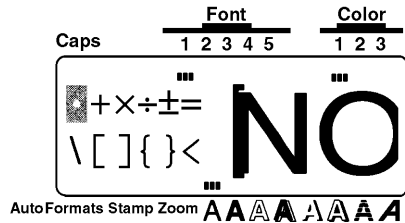
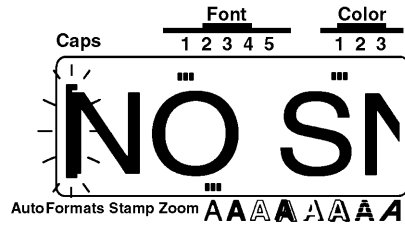

To start the Symbol function:

- Hold down  and press .



## Alt KEY

### OPERATION

- To type in a character printed in orange (P-touch 530) or blue (P-touch 550) on a key, hold down  and press the key of the character that you wish to type in.
-  To type in the capital letter of a character printed in blue, hold down  (or hold  down and press  to enter **Caps** mode) before pressing the key of the desired character.

### EXAMPLE

To type in "-":

- Hold down  and press .

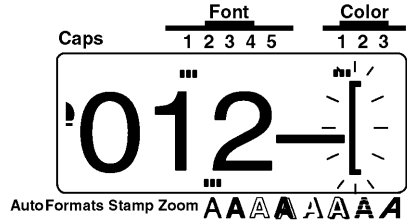
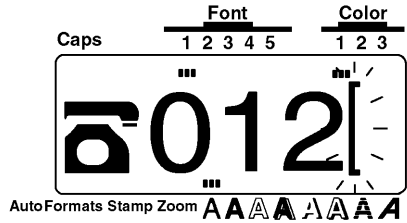



## Shift KEY

### OPERATION

- To type in a capital letter or the symbol printed in the top-hand corner of a key, hold down  and press the key of the character that you wish to type in.

### EXAMPLE

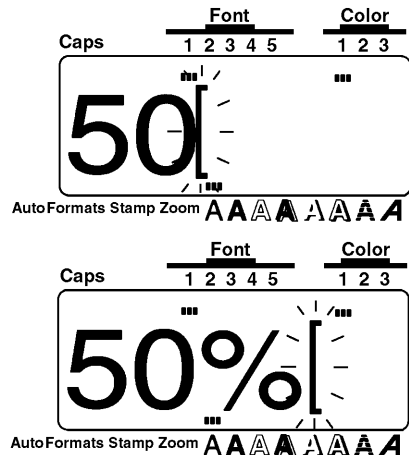

To type in "%":

- Hold down  and press .





## Caps MODE

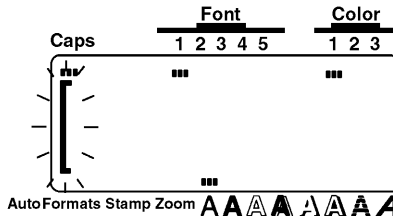

### OPERATION

- To enter **Caps** mode and type in a series of capital letters, hold down  and press . The **Caps** indicator in the top left-hand corner of the LCD display lights up.





-  The unnumbered --- not the symbol about it --- is typed in, unless  is held down while a number key is pressed.

To type lowercase letters while the **Caps** indicator is lit, hold down  while pressing the key of the desired character.

- To exit **Caps** hold down  and press . The **Caps** indicator goes off.

# Space KEY

## BACKGROUND

The **Space** key (  ) lets you add blank spaces anywhere in your text. It is different from the right cursor key (  ), which just moves the cursor through the text without adding blank spaces.

## OPERATION

- To type in a blank space, press .

## EXAMPLE

To insert a space:

- Press .

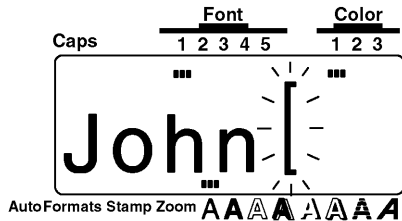
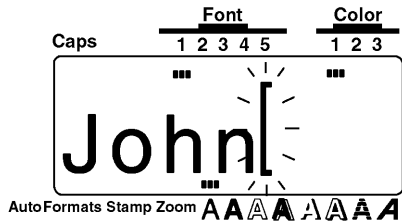

# ↵ (RETURN) KEY

## BACKGROUND

The return key (  ) has three different functions.

### ENDING A LINE OF TEXT

Once you have finished entering a line of the text, press the return key to create a new line and move the cursor to its beginning.

 A single block of text can only contain the maximum number of lines shown in the table below. If the block already contains the maximum number of lines when you press the return key, the error message "LINE LIMIT!" will appear.



Type widths	Maximum number of lines that can be entered
1/4" (6 mm)	2
3/8" (9 mm)	3
1/2" (12 mm)	3
3/4" (18 mm)	5
1" (24 mm)	7
1 1/2" (36 mm)	7

### MARKING A SELECTION

The return key can also be used to add a selected character to the text (e.g., when using the **Symbol** or **Accent** functions) or to apply the selected settings (e.g., when using  ).

### CONFIRMING AN OPERATION

Sometimes questions asking you to confirm an operation may appear on the LCD display, especially when the function that you have chosen will delete or affect files. In these cases, pressing the return key is like answering "yes".

 To answer "no", press . Refer to **Cancel KEY** on pages 68 to 70.

## OPERATION

- To add a new line of text, press .

## EXAMPLE

To add a second line:

- Press .

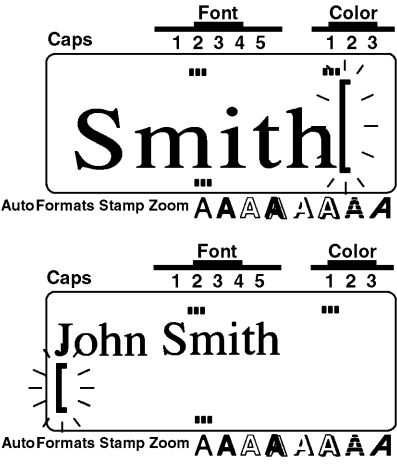

The image shows two examples of text formatting. The first example shows the word "Smith" with a font size selector (1-5) and a color selector (1-3). The second example shows the name "John Smith" with a font size selector (1-5) and a color selector (1-3). Both examples include "AutoFormats Stamp Zoom" and "Caps" options.

## OPERATION

- To apply a selected item, press .



# New Block FUNCTION

## BACKGROUND

Any time the number of lines in a section of the label changes, the **New Block** function must be used to create a new block. Creating a new block is different from local formatting, which only changes the style within a line or group of lines.



Compare these two labels:





This is simply a single-block, single-line label with local formatting. After all the text has been typed in, the position "(123) 456-7890" has been assigned a smaller character size.





This is a multi-block label. The first position of this label is a single line, the second is four lines and the third, two lines. The **New Block** function must be used to enter text like this.

 A single label can only contain a maximum of five blocks. If the cursor is located in the fifth block when  is held down and  is pressed, the error message "5 BLOCK LIMIT!" will appear.

If the cursor is positioned in the middle of a text block when  is held down and  is pressed, the block splits into two and the character on the right of the cursor becomes the beginning of the next block.

## OPERATION

- To add a new block, hold down  and press .

**EXAMPLE**

To make the label 

<b>TOMMY</b>	CLASS 2 ROOM 104
--------------	---------------------

 :

1 Type "TOMMY".

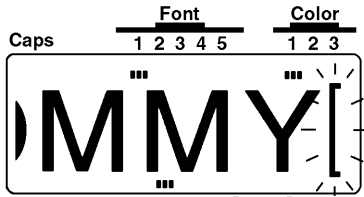

AutoFormats Stamp Zoom

2 Hold down 

Code
------

 and press 

New Block ↓
----------------

.

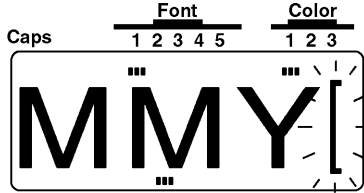

AutoFormats Stamp Zoom

3 Type "CLASS 2".

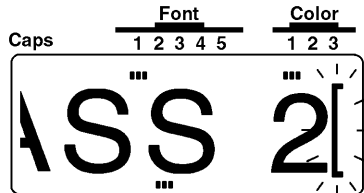

AutoFormats Stamp Zoom

4 Press 

New Block ↓
----------------

.

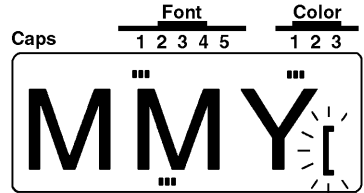

AutoFormats Stamp Zoom

5 Type "ROOM 104".

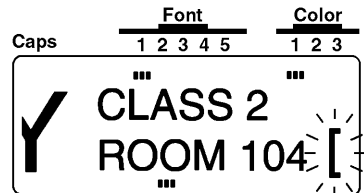

AutoFormats Stamp Zoom

# Cancel KEY

## BACKGROUND



The **Cancel** key (  ), located in the bottom row of the keyboard, has two basic functions.

## QUITTING AN OPERATION WITHOUT CHANGING THE TEXT

In general, pressing  returns you to the previous screen or operation without changing the text (e.g., if you begin using a function but later decide that you do not want to continue or if an error message is displayed).

## REJECTING AN OPERATION

Sometimes questions asking you to confirm an operation may appear on the LCD display, especially when the function that you have chosen will delete or affect files. In these cases, pressing  is like answering "no".

 To answer "yes", press . Refer to  (RETURN) KEY on pages 63 to 65.



## OPERATION

- To quit an operation, press .

## EXAMPLE

To quit the Format function without changing the label format:

- Press  to begin changing the label format functions.

- Press .

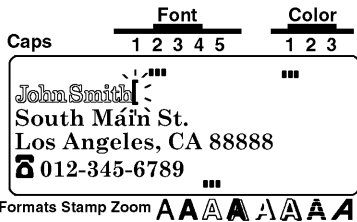
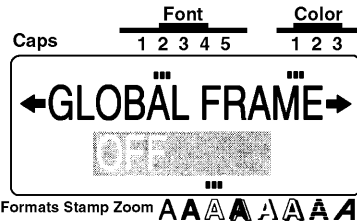
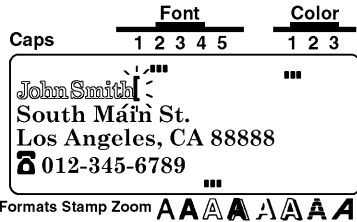

## OPERATION

- To answer "no", press .

## EXAMPLE

To cancel the Clear function:

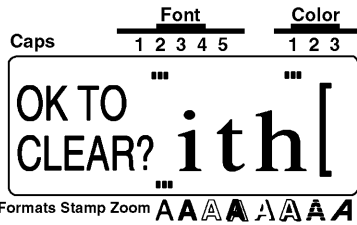

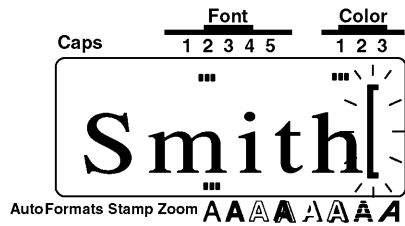

- Press .







# BS (BACKSPACE) KEY

## BACKGROUND

The backspace key () allows you to remove characters to the left of the cursor's current position. It differs from the left cursor key () , which only moves the cursor without deleting any characters.

## OPERATION

### TO DELETE A CHARACTER:

- 1 Press  ,  ,  or  to position the cursor immediately to the right of the character you want to delete.
- 2 Press  .

## EXAMPLE

To delete "East":

- 1 Press  five times.

To join the two lines together:

- 2 Press  once.

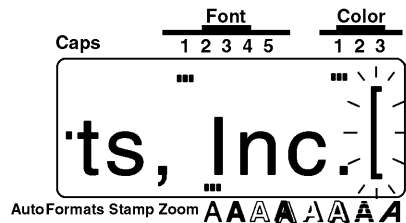
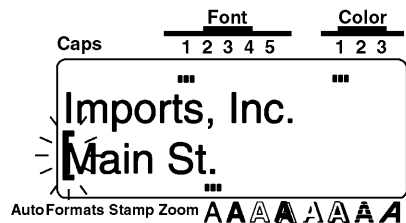
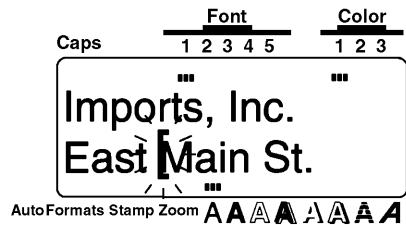







# Line Out FUNCTION

## BACKGROUND

The **Line Out** function allows you to remove entire lines of the text easily.

## OPERATION

### TO DELETE A LINE OF TEXT:

- 1 Press , ,  or  to position the cursor in the line that you want to delete.
- 2 Hold down  and press .

## EXAMPLE

To delete "East Main St.":

- Hold down  and press .

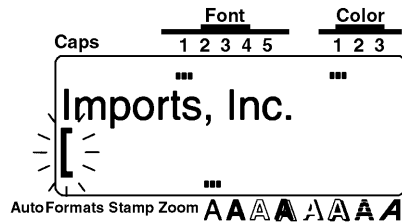
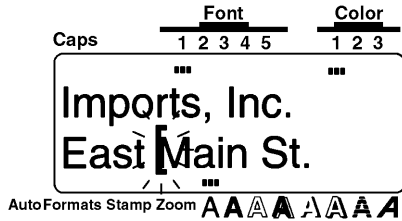

# Clear FUNCTION

## BACKGROUND

The **Clear** function is used to remove all characters from the display, and return all text formats selected (using  Font,  Size,  Width,  Style,  Undr/Flm and  Color) and label formats selected (using  Format) to their default setting. In other words, the display is completely emptied. You can then begin entering new text and formatting it.

## OPERATION

**TO ERASE ALL OF THE TEXT AND RETURN ALL FORMATS TO THEIR DEFAULT SETTINGS:**

- 1 Hold down  Code and press  Clear BS. The message "OK TO CLEAR?" appears on the display.

 *The cursor can be located anywhere in the text.*

- 2 Press  New Block .

 *To stop the text from begin erased, press  Cancel. Refer to Cancel KEY on pages 68 to 70.*

## EXAMPLE

To clear the display:

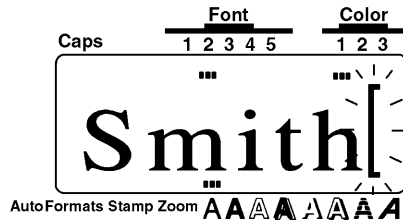

- 1 Hold down  Code and press  Clear BS.

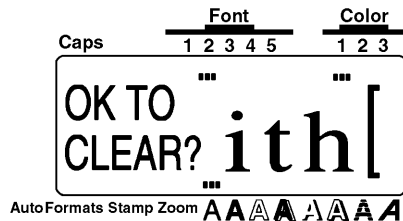

2 Press



Caps

Font					Color		
1	2	3	4	5	1	2	3
	..					..	
			..				

AutoFormats Stamp Zoom **A A A A A A A**













# Symbol FUNCTION

## BACKGROUND

In addition to the letters, symbol and numerals on the key tops, there are 257 additional characters available with the **Symbol** function. After these characters are added to the text, they can be treated like any other character and be formatted or deleted.



## OPERATION

### TO TYPE IN A SYMBOL:

- 1 Hold down  and press . Some symbols appear on the display.
  - 2 Press  or  until the symbol that you want to use appears on the display.
  - 3 Press  or  until the desired symbol is highlighted.
  - 4 Press . The selected symbol is added to the text.
-  To enter a sequence of symbols, hold down  before pressing . Continue adding symbols to your text by selecting them, then holding down  while pressing . Press just  after the last symbol in the sequence is chosen.
- Symbols cannot be typed in to a bar code.

# EXAMPLE

To add the symbol "☹":

1 Hold down  and press .

2 Press  until "☹" is highlighted.

3 Press .

	Font					Color		
Caps	1	2	3	4	5	1	2	3
AutoFormats Stamp Zoom								

	Font					Color		
Caps	1	2	3	4	5	1	2	3
AutoFormats Stamp Zoom								

	Font					Color		
Caps	1	2	3	4	5	1	2	3
AutoFormats Stamp Zoom								





# Accent FUNCTION

## BACKGROUND

When writing in other languages, accented character, which consist of a letter and a diacritical mark, are often used. The accented characters of the **Accent** function are grouped according to the capital or lowercase letter that they are combined with. The following accented characters are available:

Letters	Accented characters	Letters	Accented characters
a	áâãäåæ	i	ï í î ï
A	ÄÅÄÅÆ	I	Ï Í Î Ï
c	ç	n	ñ
C	Ç	N	Ñ
d	ð	o	öóððøœ
D	Ð	O	Ö Ó Õ Ö Ø Æ
e	éëêêë	u	üúûú
E	É Ê Ë Ë	U	Ü Ú Û Ü

☛ Several accented characters can be typed in directly while holding down  (refer to page 54).



## OPERATION

### TO TYPE IN AN ACCENTED CHARACTER:



1 Hold down  and press . The message "a -- u / A -- U?" appears on the display.

2 Press the key of the letter in the desired accented character.



☛ To type in a capital letter, hold down  while pressing the letter key.

3 Press  or  until the desired accented character is highlighted.

4 Press . The selected accented character is added to the text.



☛ To enter a sequence of accented characters, hold down  before pressing .

Continue adding accented characters to your text by selecting them, then holding

down  while pressing . Press just  after the last accented character in the sequence is chosen.

**EXAMPLE**

To add the accented character "É":

1 Hold down  and press .

Font					Color			
Caps	1	2	3	4	5	1	2	3
a-u/ A-U?	'''					'''		
								]

AutoFormats Stamp Zoom 

2 Hold down  and press .

Font					Color			
Caps	1	2	3	4	5	1	2	3
ÉÉÈÈÉ	'''					'''		
								]

AutoFormats Stamp Zoom 

3 Press  until "É" is highlighted.

Font					Color			
Caps	1	2	3	4	5	1	2	3
ÉÉÈÈÉ	'''					'''		
								]

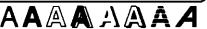
AutoFormats Stamp Zoom 

4 Press .

Font					Color			
Caps	1	2	3	4	5	1	2	3
ÉUMÉ	'''					'''		
								]

AutoFormats Stamp Zoom 

# Barcode FUNCTION

## BACKGROUND

The **Barcode** function, which allows you to add bar codes to your printed labels, is one of this machine's most advanced features.

-  This section will explain how to enter a bar code into your text. It is not intended as a comprehensive introduction to the concept of bar coding. For more detailed information, please consult one of the many reference books available. Since this machine is not specifically designed for special bar code label-making, some bar code readers may not be able to read the labels. Bar code should be printed on labels with back ink on a white background.

Four different parameters enable you to create custom bar codes.



Parameters	Settings
PROTOCOL	CODE 39, 1-2/5, EAN13, EAN8, UPC-A, UPC-E, CODABAR, EAN128*, CODE128* ISBN 5*, ISBN 2* *Only available on the P-touch 550
WIDTH(bar code width)	LARGE, SMALL
UNDER#S (numbers printed below bar code)	ON, OFF
CHECK DIG. (check digit)	OFF, ON



The default settings are CODE 39 PROTOCOL, LARGE WIDTH, the UNDER#S set to ON, and CHECK DIG. set to OFF.

-  It is recommended that bar codes be printed with the FEED (tape feed) function set to FULL and the bar code WIDTH parameter set to LARGE; otherwise, bar codes may be difficult to read.

## OPERATION

### TO CREATE A BAR CODE

- ① Hold down  and press .

-  To change the data or parameters of a bar code that has already been created, position the cursor in the middle of the bar code mark before holding down  and pressing , then change the bar code data or its parameters.

### Selecting the bar code parameter settings

- ② Press .

To continue creating a bar code without changing any of its parameter settings, press

.

3 Press or until the parameter setting that you want to change is highlighted.

4 Press or until the desired setting is displayed.

To select the default setting, press .

5 Repeat steps 3 and 4 until all parameters are set as you wish.

6 Press .

### Entering the bar code data

7 Type in the new bar code data or edit the old data.

### Adding a special character to the bar code data

8 Press or until the cursor is below the character to the right of the position where you want to add the special character.

9 Hold down and press .

10 Press or until the desired special character is displayed.

The following symbols can only be entered when using protocols EAN 128 or CODE 128.

VALUE	CHARACTER	VALUE	CHARACTER	VALUE	CHARACTER
3	#	69	ENQ	87	ETB
4	\$	70	ACK	88	CAN
11	+	71	BEL	89	EM
28	<	72	BS	90	SUB
29	=	73	HT	91	ESC
30	>	74	LF	91	{
32	@	75	VT	92	FS
59	[	76	FF	92	
60	\	77	CR	93	GS
61	]	78	SO	93	}
62	~	79	SI	94	RS
63	_	80	DLE	94	~
64	NUL	81	DC1	95	US
64	`	82	DC2	95	DEL
65	SOH	83	DC3	96	FNC3
66	STX	84	DC4	97	FNC2
67	ETX	85	NAK	100	FNC4
68	EOT	86	SYN	102	FNC1

The following symbols can only be entered when using protocols CODE 39 or CODABAR.

SYMBOL	CHARACTER
1	+
2	\$

11 Press  to add the selected special character to the bar code data.



 To return to entering the bar code data without adding a special character, press .

**Adding the bar code to your text**

12 Press .

## EXAMPLE

To create a bar coide with protocol EAN 128:

① Hold down  and press .

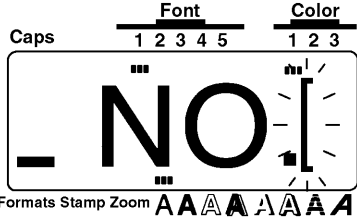

② Press .

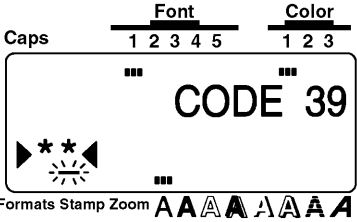

③ Press  until the PROTOCOL parameter is set to EAN 128.

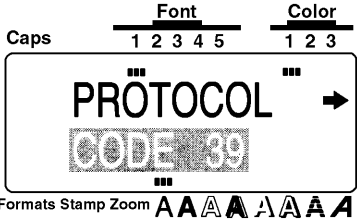

④ Press .

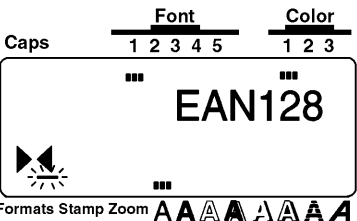
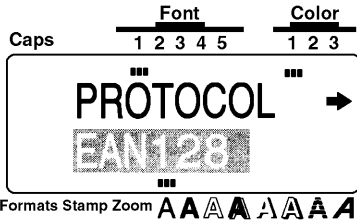

5 Type in the bar code data "123456".

Caps	Font					Color		
	1	2	3	4	5	1	2	3
	'''				'''			
	<b>EAN128</b>							
	▶123456◀							

AutoFormats Stamp Zoom **A A A A A A A**

6 Press 

Caps	Font					Color		
	1	2	3	4	5	1	2	3

AutoFormats Stamp Zoom **A A A A A A A**



# Zoom KEY

## BACKGROUND

Normally, text is entered and displayed in the WYSIWYG (what-you-see-is-what-you-get) mode, which shows you exactly how the label would appear if it were printed. With the **Zoom** key, however, you can zoom in to see the text in detail, or you can zoom out to see how the text would fit on the printed label.

## OPERATION

### TO USE THE ZOOM FUNCTION:

- 1 Press **Zoom** once to enlarge the text. The **Zoom** indicator at the bottom of the display lights up.  
 To return the display to WYSIWYG mode, press **Cancel** at any time.
- 2 Press **Zoom** again to shrink the text. The **Zoom** indicator stays lit.
- 3 Press **Zoom** one more time to return the display to WYSIWYG mode. The **Zoom** indicator goes off.

## EXAMPLE

To zoom in on and out from the text:

- 1 Press **Zoom**. The display zooms in on the text.

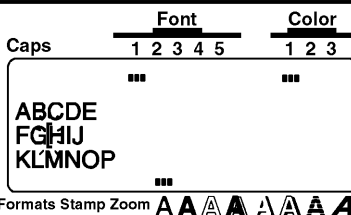

- 2 Press **Zoom**. The display zooms out from the text.

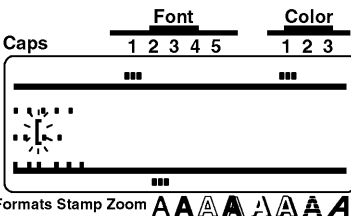
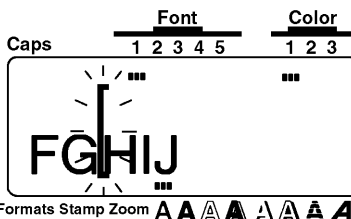









# Contrast FUNCTION

## BACKGROUND

This function is used to make the LCD display lighter or darker. The **Contrast** function can be used from the WYSIWYG display mode or while using the auto formats or **Stamp** functions.



## OPERATION

### TO CHANGE THE CONTRAST:



- 1 Hold down  and press .
- 2 Press  or  to adjust the contrast.  
*To reset the contrast to its default setting, press  (or hold down  and press ).*
- 3 Press .

## EXAMPLE

### To adjust the display contrast:

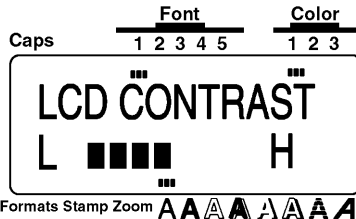
- 1 Hold down  and press .



- 2 Press  or  to adjust the contrast, then press .

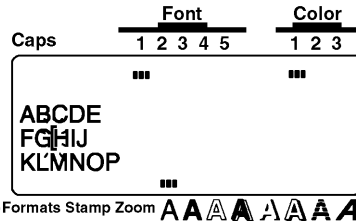

# Label Length FUNCTION

## BACKGROUND

This function is used to display the length of the label in either inches or centimeters depending on the setting of the UNIT function. For more information on changing the units that are used when displaying the length, see *UNIT FUNCTION* on page 121.

## OPERATION

- To display the length of the label, hold down  and press .  
To return to the WYSIWYG display mode, press .

## EXAMPLE

To display the length of the label:

- Hold down  and press .

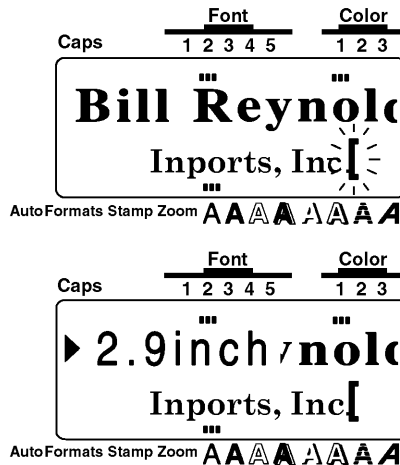

# Auto Formats KEY



## BACKGROUND





The **Auto Formats** key () is located in the lower left-hand corner of the keyboard. After pressing this key, simply select a preset template and enter text in each of the template's entries to create labels for a variety of uses, such as addressing envelopes and identifying floppy disks or audio and video cassettes. This function makes label-making faster and easier than formatting the text yourself. For a list of label templates and their entries, refer to pages 91 through 96.

## OPERATION

### TO USE THE AUTO FORMATS FUNCTION:

1 Press . The **Auto Formats** indicator lights up.

 If text has already been entered in the display, the message "OK TO CLEAR TEXT BUFFER?" appears. Press  to delete the text.

If the **Auto Formats** indicator was already lit when  was pressed, you can choose either the **NEW TEXT** setting to create new text, or the **EDIT TEXT** setting to edit the currently displayed text. Press  or  to select the desired setting, then press .

### Selecting a template for creating new text

2 Press  or  until the template that you want use is displayed.

3 Press .

### Entering or editing text in the template



4 For each entry, type in the text, then press . When  is pressed after entering the text for the last entry, the message "OK TO FINISH INPUTTING DATA" appears.

5 Press  to return to the WYSIWYG display mode.

**EXAMPLE**

To quickly create a name tag:

1 Press . The **Auto Formats** indicator lights up.

2 Press  or  until the template "NAME PLATE" is displayed.

3 Press .

4 Type in the name "Bill Reynolds", then press



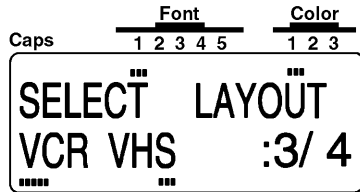

5 Type in the company name "Imports, Inc.", then press .

6 Press  to return to the WYSIWYG display mode.

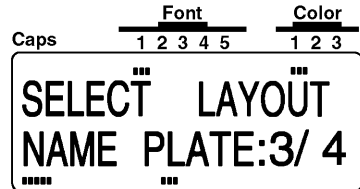

AutoFormats Stamp Zoom 



AutoFormats Stamp Zoom 

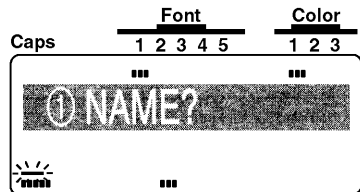

AutoFormats Stamp Zoom 

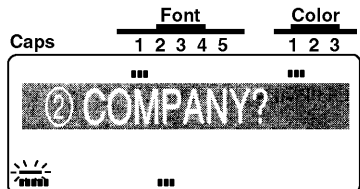

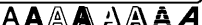
AutoFormats Stamp Zoom 



AutoFormats Stamp Zoom 

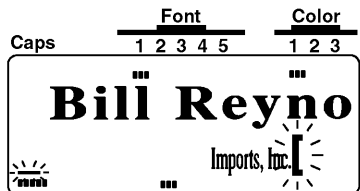

AutoFormats Stamp Zoom 

# LIST

Preset Label Templates	Entries	
A. VCR VHS (3/4" (18mm))	1. SYMBOL? 2. TITLE? 3. SNB-TITLE?	4. DURATION 5. REC. MODE? 6. DATE?
B. VCR 8mm-1 (3/8" (9mm))	1. SYMBOL? 2. TITLE? 3. SUB-TITLE?	4. DATA? 5. REC. MODE?
C. VCR 8mm-2 (1.2" (12mm))	1. SYMBOL? 2. TITLE? 3. SUB-TITLE?	4. DURATION? 5. REC. MODE? 6. DATE?
D. VCR VHSC-1 (1/2" (12mm))	1. TITLE?	2. SUB-TITLE?
E. VCR VHSC-2 (3/4" (18mm))	1. SYMBOL? 2. TITLE? 3. SUB-TITLE?	4. DURATION? 5. REC. MODE? 6. DATE?
F. AUDIO-1 (1/4" (6mm))	1. SYMBOL? 2. TITLE?	3. SUB-TITLE?
G. AUDIO-2 (3/8" (9mm), 1/2" (12mm))	1. SYMBOL? 2. TITLE?	3. SUB-TITLE?
H. AUDIO-3 (3/8" (9mm), 1/2" (12mm))	1. SYMBOL?	2. TITLE?
I. NAME PLATE (3/4" (18mm), 11/2" (36mm))	1. NAME?	2. COMPANY?
J. ADDRESS (3/4" (18mm), 1" (24mm), 11/2" (36mm))	1. NAME? 2. ADDRESS1?	3. ADDRESS2? 4. ADD.3/TEL?
K. EQUIPMENT (3/4" (18mm), 1" (24mm), 11/2" (36mm))	1. TITLE? 2. NAME?	3. NUMBER?
L. EQUIPMENT (1/2" (12mm))	1. TITLE? 2. SUB-TITLE?	3. NAME? 4. NUMBER?
M.SLIDE (1/2" (12mm))	1. TITLE? 2. DATE?	3. SUB-TITLE?
N. PRICE (3/4" (18mm), 1" (24mm), 11/2" (36mm))	1. NAME?	2. PRICE?
O. SALE PRICE (3/4" (18mm), 1" (24mm), 11/2" (36mm))	1. NAME? 2. OLD PRICE?	3. NEW PRICE?
P. FILE LONG (3/4" (18mm), 1" (24mm), 11/2" (36mm))	1. TITLE?	
Q. FILE LONGV (3/4" (18mm), 1" (24mm), 11/2" (36mm))	1. TITLE?	
R. FILE SHORT (3/8" (9mm), 1/2" (12mm), 3/4" (18mm), 1" (24mm), 11/2" (36mm))	1. TITLE?	
S. FLOPPY 3.5" (3/4" (18mm), 1" (24mm), 11/2"(36mm))	1. TITLE? 2. SUB-TITLE?	3. NAME?
T. FLOPPY 5" (3/4" (18mm), 1" (24mm), 11/2"(36mm))	1. TITLE? 2. SUB-TITLE?	3. NAME?

**SAMPLES**

A. VCR VHS (3/4" (18 mm))

	<b>CHAMPION'S CUP</b> MEN'S SINGLE	90min STANDARD AUG.5,1995
---	---------------------------------------	---------------------------------

B. VCR 8mm-1 (3/8" (9 mm))

	<b>A SNOWY DAY</b> Mick's first ski experience	JAN.3,1995 Valdisel
---	---	------------------------

C. VCR 8mm-2 (1/2" (12 mm))

	<b>Kelly's 1st Birthday</b> Birthday Party	120 min SLOW Jan. 10, 1995
---	---	----------------------------------

D. VCR VHSC-1 (1/2" (12 mm))

	<b>JOE &amp; ANN'S WEDDING</b> St. Michael's Church
---	--

E. VCR VHSC-2 (3/4" (18 mm))

	<b>JOE &amp; ANN'S WEDDING</b> St. Michael's Church	120min NORMAL 11.6,'95
---	--	------------------------------

F. AUDIO-1 (1/4" (6 mm))

	<b>FAVORITE LOVE SONGS</b>	Mari
---	----------------------------	------

G. AUDIO-2 (3/8" (9 mm))

	<b>FAVORITE LOVE SONGS</b> Mari
---	------------------------------------

AUDIO-2 (1/2" (12 mm))

	<b>FAVORITE LOVE SONGS</b> Mari
---	------------------------------------

H. AUDIO-3 (3/8" (9 mm))

	<b>OLDIES(1960 – 1970)</b>
---	----------------------------

AUDIO-3 (1/2" (12 mm))

	<b>OLDIES(1960 – 1970)</b>
---	----------------------------

I. NAME PLATE (3/4" (18 mm))

**Bill Reynolds**  
ABC INTERNATIONAL CORP.

NAME PLATE (1" (24 mm))

**Bill Reynolds**  
ABC INTERNATIONAL CORP.

NAME PLATE (1 1/2" (36 mm))

**Bill Reynolds**  
ABC INTERNATIONAL CORP.

J. ADDRESS (3/4" (18 mm))

**Smith's Rent-A-Bike**  
29 Green Road  
Los Angeles, CA 88888  
123-456-7890

ADDRESS (1" (24 mm))

**Smith's Rent-A-Bike**  
29 Green Road  
Los Angeles, CA 88888  
123-456-7890

ADDRESS (1 1/2" (36 mm))

**Smith's Rent-A-Bike**  
29 Green Road  
Los Angeles, CA 88888  
123-456-7890

K. EQUIPMENT (3/4" (18 mm))

PROPERTY OF  
SALES & MARKETING DIV.  
0312



EQUIPMENT (1" (24 mm))

PROPERTY OF  
SALES & MARKETING DIV.  
0312

EQUIPMENT (1 1/2" (36 mm))

PROPERTY OF  
SALES & MARKETING DIV.  
0312

L. EQUIPMENT (1/2" (12 mm))

PROPERTY OF	SALES & MARKETING DIV.
NUMBER	0235

M. SLIDE (1/2" (12 mm))

HAWAII ISLAND
AUG. 15, 1994
ISO: 70

N. PRICE (3/4" (18 mm))

LABEL PRINTER  
**\$249**

PRICE (1" (24mm))

LABEL PRINTER  
**\$249**

PRICE (1 1/2" (36 mm))

LABEL PRINTER  
**\$249**

O. SALE PRICE (3/4" (18 mm))

LABEL PRINTER  
~~\$249~~ ➔ **\$229**

SALE PRICE (1" (24 mm))

LABEL PRINTER  
~~\$249~~ ➔ **\$229**

SALE PRICE (1 1/2" (36 mm))

LABEL PRINTER

~~\$249~~

➔ **\$229**

P. FILE LONG (3/4" (18 mm))

**'94 MARKET RESEARCH ①**

FILE LONG (1" (24 mm))

**'94 MARKET RESEARCH ①**

FILE LONG (1 1/2" (36 mm))

**'94 MARKET RESEARCH ①**

Q. FILE LONGV (3/4" (18 mm))

**M A R K E T R E S E A R C H ①**

FILE LONGV (1" (24 mm))

**M A R K E T R E S E A R C H ①**

FILE LONGV (1 1/2" (36 mm))

**M A R K E T R E S E A R C H ①**

R. FILE SHORT (3/8" (9 mm))

**SALES RESULTS (1)**

FILE SHORT (1/2" (12 mm))

**SALES RESULTS (1)**

FILE SHORT (3/4" (18 mm))

**SALES RESULTS (1)**

FILE SHORT (1" (24 mm))

**SALES RESULTS (1)**

FILE SHORT (1 1/2" (36 mm))

**SALES RESULTS (1)**

S. FLOPPY 3.5" (3/4" (18 mm))

**DAILY FAX (5)**

9/94 - Preset

J. Smith

FLOPPY 3.5" (1" (24 mm))

**DAILY FAX (5)**

9/94 - Preset

J. Smith

FLOPPY 3.5" (1 1/2" (36 mm))

**DAILY FAX (5)**

9/94 - Preset

J. Smith

T. FLOPPY 5" (3/4" (18 mm))

**NEW PRODUCTS (3)**

Nov. Presentation

J. Smith

FLOPPY 5" (1" (24 mm))

<b>NEW PRODUCTS (3)</b>
Nov. Presentation
J. Smith

FLOPPY 5" (1 1/2" (36 mm))

<b>NEW PRODUCTS (3)</b>
Nov. Presentation
J. Smith

# Area KEY AND All FUNCTION

## BACKGROUND

You can make more decorative labels using the text format keys (  ,  ,  ,  ,  , and  ) to change the appearance of part or all of the characters in your text either before or after you have entered them. After the text is entered, use the **All** function to select all of the text, or press  and use  ,  ,  and  to select part of the text for formatting. Since the text can be displayed with the WYSIWYG mode, you can see exactly how the label will appear before it is printed. (For mode details on the text format keys, refer to pages 100 through 109.)

 When the entire text is removed from the display with the **Clear** function, all text formats (font, size, width, style, underline/frame and color) will return to their default settings.

## OPERATION

### TO SELECT THE TEXT FORMAT BEFORE ENTERING THE TEXT:

1 Press the text format key for the format that you want to change. The sample letter (**A**) appears on the right side of the cursor.

2 Keep pressing the text format key until the "A" is formatted as you wish or the desired setting is displayed.

 To select the default setting for a certain text format, hold down  while pressing the corresponding text format key.

To change all text formats to their default settings, hold down  and press .

To select the previous text format setting, hold down  while pressing the corresponding text format key.

3 If you want to change other text formats, repeat steps 1 and 2 until all of the desired text formats are set.

4 Enter the text. All of the text that you enter is displayed with the selected format.

### TO CHANGE THE TEXT FORMAT AFTER ENTERING THE TEXT:

#### Changing the text format for all of the text

1 Hold down  and press . All of the text is highlighted.

 To quit the operation without changing the text format, press  (or hold down  and press ) at any time.

2 Press the text format key (for the format that you want to change) until the text is displayed with the text format setting that you want.

 To select the default setting for a certain text format, hold down  while pressing the corresponding text format key.

To change all text formats to their default settings, hold down  and press .

To select the previous text format setting, hold down  while pressing the corresponding text format key.

3 If you want to change other text formats, repeat step 2 until all of the desired text formats are set.

4 Press . All of the text is displayed with the selected text formats.

### Changing the text format for only part of the text

1 Press , , , or to position the cursor on the left side of the first character whose text format setting you want to change.

2 Press . The first character to the right of the cursor is highlighted.

To put the operation without changing the text format, press (or ) at any time.

3 Press , , , or to highlight all characters whose text format setting you want to change.

4 Press the text format key (for the format that you want to change) until the text is displayed with the format setting that you want.

To select the default setting for a certain text format, hold down while pressing the corresponding text format key.

To change all text formats to their default settings, hold down and press .

To select the previous text format setting, hold down while pressing the corresponding text format key.

5 If you want to change other text formats, repeat step 4 until all of the desired text formats are set.

6 Press . The chosen text is displayed with the selected text formats.

### EXAMPLE

To select the second smallest character size and the italic and bold styles for all of the text:

1 Hold down and press .

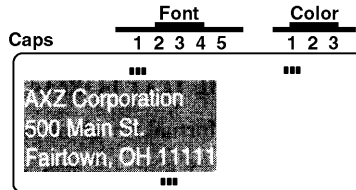

2 Press until the text is displayed in the second smallest size setting (9 points).

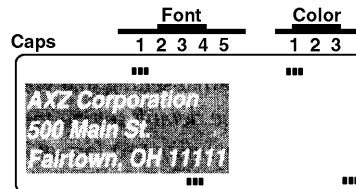

3 Press until the text is displayed in the bold ( **A** ) and the italic ( *A* ) style settings and their indicators light up.

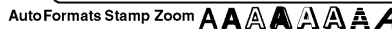



4 Press .

	Font	Color
Caps	1 2 3 4 5	1 2 3
	...	...
	<b>AXZ Corporation</b>	
	<b>500 Main St.</b>	
	<b>Fairtown, OH 11111</b>	
	...	...

AutoFormats Stamp Zoom 

To underline the company name:

5 Hold down  and press .

	Font	Color
Caps	1 2 3 4 5	1 2 3
	...	...
	<u><b>AXZ Corporation</b></u>	
	<b>500 Main St.</b>	
	<b>Fairtown, OH 11111</b>	
	...	...

AutoFormats Stamp Zoom 

6 Press .

	Font	Color
Caps	1 2 3 4 5	1 2 3
	...	...
	 <b>AXZ Corporation</b>	
	<b>500 Main St.</b>	
	<b>Fairtown, OH 11111</b>	
	...	...

AutoFormats Stamp Zoom 

7 Press  until the company name "AXZ Corporation" is highlighted.

	Font	Color
Caps	1 2 3 4 5	1 2 3
	...	...
	 <b>AXZ Corporation</b>	
	<b>500 Main St.</b>	
	<b>Fairtown, OH 11111</b>	
	...	...

AutoFormats Stamp Zoom 

8 Press  until the company name is underlined.

	Font	Color
Caps	1 2 3 4 5	1 2 3
	...	...
	 <b>AXZ Corporation</b>	
	<b>500 Main St.</b>	
	<b>Fairtown, OH 11111</b>	
	...	...

AutoFormats Stamp Zoom 

9 Press .

	Font	Color
Caps	1 2 3 4 5	1 2 3
	...	...
	<u> <b>AXZ Corporation</b></u>	
	<b>500 Main St.</b>	
	<b>Fairtown, OH 11111</b>	
	...	...

AutoFormats Stamp Zoom 

# Font KEY

## BACKGROUND

With the **Font** key (  ), you can change the font of your text to one of the many that are available.

The following font settings are available on the P-touch 530:

Font 1 (Helsinki), Font 2 (Brussels), Font 3 (Calgary), Font 4 (US), Font 5 (Belgium)





The following font settings are available on the P-touch 550:

Font 1 (Helsinki), Font 2 (Brussels), Font 3 (Calgary), Font 4 (US), Font 5 (San Diego),  
Font 6 (Florida), Font 7 (Istanbul), Font 8 (Bermuda)

The selected font setting for the cursor's current position is shown by the **Font** indicator at the top of the display. The default font setting is Font 1 (Helsinki). Refer to *SAMPLES* at the end of this section for samples of the available settings.









## OPERATION

### TO SELECT A FONT BEFORE ENTERING TEXT:

- 1 Press , ,  or  to move the cursor to the position where you want to begin using a different font setting.
- 2 Press  until the sample character (**A**) is displayed with the font setting that you want to use. The currently selected font is shown by the **Font** indicator at the top of the LCD display.
- 3 Enter the new text.



## TO CHANGE THE FONT OF A SELECTED AREA:

- 1 Select the text by holding down  and pressing  to select all of the text, or by pressing  and using , ,  or  to select only a part of it.
- 2 Press  until the text is displayed with the font setting that you want to use. The currently selected font is shown by the **Font** indicator at the top of the LCD display.
- 3 Press . The chosen text is displayed with the selected font.

## SAMPLES

P-touch 530	P-touch 550	Font Name	Font Samples
Font 1	Font 1	Helsinki	ABCDE
Font 2	Font 2	Brussels	ABCDE
Font 3	Font 3	Calgary	<i>ABCDE</i>
Font 4	Font 4	US	ABCDE
Font 5	Not available	Belgium	ABCDE
Not available	Font 5	San Diego	<b>ABCDE</b>
Not available	Font 6	Florida	<b>ABCDE</b>
Not available	Font 7	Istanbul	<b>ABCDE</b>
Not available	Font 8	Bermuda	<i>ABCDE</i>

# Size AND Width KEYS

## BACKGROUND

The character size can be adjusted using both the **Size** () and **Width** () keys. With the AUTO size setting, the machine compares your text with the width of the installed tape and automatically adjusts the characters to the largest possible size. However, seven other point sizes are available and each can be printed in narrow, medium or wide characters.

The default size setting is AUTO and the default width setting is medium. When the AUTO size setting is selected, "AUTO" appears in the top left-hand corner of the display. Refer to *SAMPLE* at the end of this section for samples of the available settings.

 When the **SPLIT** parameter of the **Special Print** function is set ON, the text will automatically be printed in a larger character size. Refer to Special Print FUNCTION on pages 128 to 129 for more details.

Since the character size that can be used depends on the width of the tape, the following table shows the character sizes that can be used with each tape width.











Tape width	Sizes (in point)
1 1/2" (36 mm)	6, 9, 12, 18, 24, 36, 48
1" (24 mm)	6, 9, 12, 18, 24, 36, 48
3/4" (18 mm)	6, 9, 12, 18, 24, 36
1/2" (12 mm)	6, 9, 12, 18, 24
3/8" (9 mm)	6, 9, 12, 18
1/4" (6 mm)	6, 9, 12

## OPERATION

### TO SELECT A SIZE & WIDTH BEFORE ENTERING TEXT:

- 1 Press    or  to move the cursor to the position where you want to begin using a different character size or width setting.
- 2 Press  until the sample character (A) is displayed with the character size setting that you want to use, and press  until the sample character is displayed with the desired width setting.
- 3 Enter the new text.

## TO CHANGE THE SIZE & WIDTH OF A SELECTED AREA:

- 1 Select the text by holding down  and pressing  to select all of the text, or by pressing  and using , ,  or  to select only a part of it.
- 2 Press  until the text is displayed with the character size setting that you want to use, and press  until the text is displayed with the desired width setting.
- 3 Press . The chosen text is displayed with the selected font.

## SAMPLES

WIDTH SIZE	Wide	Medium	Narrow
48 pt	ABC	ABC	ABC
36 pt	ABC	ABC	ABC
24 pt	ABC	ABC	ABC
18 pt	ABC	ABC	ABC
12 pt	ABC	ABC	ABC
9 pt	ABC	ABC	ABC
6 pt	ABC	ABC	ABC

# Style KEY

## BACKGROUND

You can choose to apply one of 14 different styles to create a more decorative label. The following style settings are available:





A (normal)	A (italic)
A (bold)	A & A (italic & bold)
A (outline)	A & A (italic & outline)
A (solid)	A & A (italic & solid)
A (shadow)	A & A (italic & shadow)
A (outline + shadow)	A & A (italic & outline + shadow)
A (striped)	A & A (italic & striped)

The selected style setting for the cursor's current position is shown by the style indicators at the bottom of the display. The default setting is A (normal). Refer to *SAMPLES* at the end of this section for samples of the available settings.









☛ *Characters printed using the smaller size settings may be difficult to read if certain style settings (e.g., italic & shadow) are selected.*

## OPERATION

### TO SELECT A STYLE BEFORE ENTERING TEXT:

- 1 Press , ,  or  to move the cursor to the position where you want to begin using a different style setting.
- 2 Press  until the sample character (A) is displayed with the style setting that you want to use. The currently selected style is shown by the style indicators at the bottom of the LCD display.
- 3 Enter the new text.

**TO CHANGE THE STYLE OF A SELECTED AREA:**

- 1 Select the text by holding down  and pressing  to select all of the text, or by pressing  and using , ,  or  to select only a part it.
- 2 Press  until the text is displayed with the style setting that you want to use. The currently selected style is shown by the style indicators at the bottom of the LCD display.
- 3 Press . The chosen text is displayed with the selected style.

**SAMPLES**

	A (normal)	A (bold)	A (outline)	A (solid)	A (shadow)	A (outline+ shadow)	A (striped)
Helsinki	ABC	ABC	ABC	ABC	ABC	ABC	ABC
Brussels	ABC	ABC	ABC	ABC	ABC	ABC	ABC
Calgary	ABC	ABC	ABC	ABC	ABC	ABC	ABC
US	ABC	ABC	ABC	ABC	ABC	ABC	ABC
Belgium <sup>1</sup>	ABC	ABC	ABC	ABC	ABC	ABC	ABC
San Diego <sup>2</sup>	ABC	ABC	ABC	ABC	ABC	ABC	ABC
Florida <sup>2</sup>	ABC	ABC	ABC	ABC	ABC	ABC	ABC
Istanbul <sup>2</sup>	ABC	ABC	ABC	ABC	ABC	ABC	ABC
Bermuda <sup>2</sup>	ABC	ABC	ABC	ABC	ABC	ABC	ABC

<sup>1</sup> This font is not available on the P-touch 530.

<sup>2</sup> These fonts are not available on the P-touch 550.

	<b>A</b> (italic)	<b>A &amp; A</b> (italic & bold)	<b>A &amp; A</b> (italic & outline)	<b>A &amp; A</b> (italic & solid)	<b>A &amp; A</b> (italic & shadow)	<b>A &amp; A</b> (italic & outline+shadow)	<b>A &amp; A</b> (italic & striped)
Helsinki	<i>ABC</i>	<b>ABC</b>	<i>ABC</i>	<b>ABC</b>	<i>ABC</i>	<i>ABC</i>	<i>ABC</i>
Brussels	<i>ABC</i>	<b>ABC</b>	<i>ABC</i>	<b>ABC</b>	<i>ABC</i>	<i>ABC</i>	<i>ABC</i>
Calgary	<i>ABC</i>	<b>ABC</b>	<i>ABC</i>	<b>ABC</b>	<i>ABC</i>	<i>ABC</i>	<i>ABC</i>
US	<i>ABC</i>	<b>ABC</b>	<i>ABC</i>	<b>ABC</b>	<i>ABC</i>	<i>ABC</i>	<i>ABC</i>
Belgium <sup>1</sup>	<i>ABC</i>	<b>ABC</b>	<i>ABC</i>	<b>ABC</b>	<i>ABC</i>	<i>ABC</i>	<i>ABC</i>
San Diego <sup>2</sup>	<b>ABC</b>	<b>ABC</b>	<i>ABC</i>	<b>ABC</b>	<i>ABC</i>	<i>ABC</i>	<b>ABC</b>
Florida <sup>2</sup>	<b>ABC</b>	<b>ABC</b>	<i>ABC</i>	<b>ABC</b>	<i>ABC</i>	<i>ABC</i>	<b>ABC</b>
Istanbul <sup>2</sup>	<b>ABC</b>	<b>ABC</b>	<i>ABC</i>	<b>ABC</b>	<i>ABC</i>	<i>ABC</i>	<b>ABC</b>
Bermuda <sup>2</sup>	<i>ABC</i>	<b>ABC</b>	<i>ABC</i>	<b>ABC</b>	<i>ABC</i>	<i>ABC</i>	<i>ABC</i>

<sup>1</sup> This font is not available on the P-touch 530.

<sup>2</sup> These fonts are not available on the P-touch 550.

# Und/Frm (UNDERLINE/FRAME) KEY

## BACKGROUND

With the **Und/Frm** key (,), you can choose from a variety of highlights for emphasizing part of your text. The default setting is plain text without any of the following underline/frame settings.

Box



Dots



Lattice



Rounded box



Bricks



Diamond grid



Underline



Square grid



Stripes



Strike-out



Checks









Cubes











## OPERATION

**TO SELECT AN UNDERLINE/FRAME SETTING BEFORE ENTERING TEXT:**

- 1 Press , ,  or  to move the cursor to the position where you want to begin using a different underline/frame setting.
- 2 Press  until the sample character (**A**) is displayed with the underline/frame setting that you want to use.
  -  *If an underline, frame or shading has already been applied to the text, only the settings that can be combined with them are shown.*
- 3 Enter the new text.

## TO CHANGE THE UNDERLINE/FRAME SETTING FOR A SELECTED AREA:

- 1 Select the text by holding down  and pressing  to select all of the text, or by pressing  and using , ,  or  to select only a part of it.
- 2 Press  until the text is displayed with the underline/frame setting that you want to use.  
*☞ If an underline, frame or shading has already been applied to the selected text, only the settings that can be combined with them are shown.*
- 3 Press . The chosen text is displayed with the selected underline/frame.



# Color KEY





## BACKGROUND

With the **Color** key (  ), you can select different parts of the text to be printed in different ink colors for creating colorful labels.









The selected color setting for the cursor's current position is shown by the **Color** indicator at the top of the display. The default setting is COLOR1. For more details on color printing, refer to *COLOR PRINT FUNCTION* on page 123 to 124.

## OPERATION

### TO SELECT A COLOR SETTING BEFORE ENTERING TEXT:



- 1 Press , ,  or  to move the cursor to the position where you want begin using a different color setting.
- 2 Press  until the color setting that you want to use to displayed. The currently selected color setting is shown by the **Color** indicator at the top of the LCD display.
- 3 Enter the new text.

### TO CHANGE THE COLOR SETTING FOR A SELECTED AREA:

- 1 Select the text by holding down  and pressing  to select all of the text, or by pree  and using , ,  or  to select only a part of it.
- 2 Press  until the color setting that you want to use is displayed. The currently selected color setting is shown by the **Color** indicator at the top of the LCD display.
- 3 Press . The chosen text is given the selected color setting.

# Format KEY

## BACKGROUND



The **Format** key () is used to change label formats, which determine the appearance and arrangement of the entire text. Press  to change these formats at any time --- before, during or after you enter your text.

When the text is displayed in the WYSIWYG mode, you can see exactly how the label will appear before it is printed. (For more details on the label functions, refer to pages 112 through 121.)



## OPERATION



### TO CHANGE THE LABEL FORMAT:



① Press .

 To quit the operation without changing any label formats, press  (or ) at any time.

② Press  or  until the function setting that you want to change is highlighted.

③ Press  or  until the desired setting is displayed.

 To select the default setting, press .

To change all label format functions to their default settings, hold down  and press .

④ Repeat steps ② and ③ until all functions are set as you wish.

⑤ Press . The text is displayed with the selected format.

# EXAMPLE

To center the text and put a box around it:

1 Press **Format**.

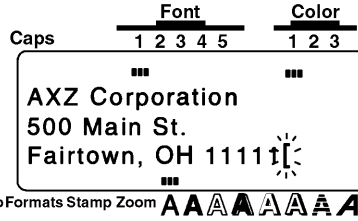

2 Press **Name** or **End** until the box setting ( ) is selected for the GLOBAL FRAME function.

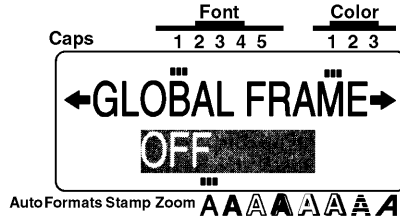

3 Press **Left** or **Right** setting for the H.ALI (horizontal alignment) function is highlighted.

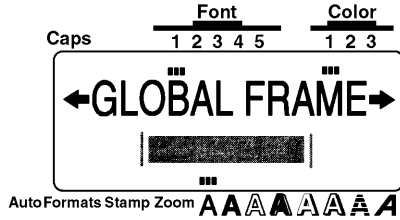

4 Press **Home** or **End** until the CENTER setting is selected.

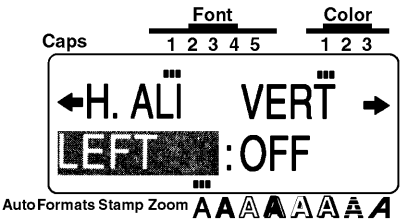

5 Press **New Block**.

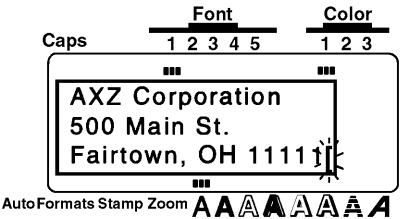
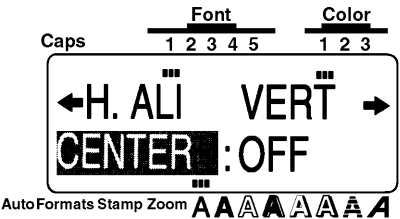

# GROBAL FRAME FUNCTION

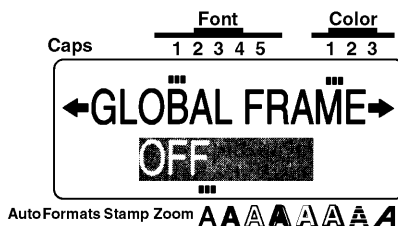

## BACKGROUND

Unique labels can be created by emphasizing your entire text with one of the many frames and shading available. The default setting is OFF (no frame or shading); however, the following settings are also available.

### Box



### Square grid



### Stripes

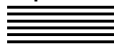

### Wooden sings

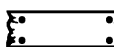

### Telephone

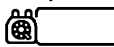

### Rounded box



### Checks



### Cubes



### Dog

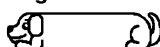

### Hands

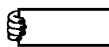

### Dots



### Lattice



### Sale



### Film

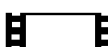

### Window

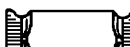

### Dricks



### Diamond grid

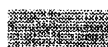

### Pointing finger

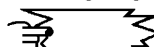

### Dinosaur

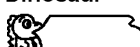



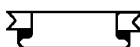



### Banner



 The GLOBAL FRAME function can only be applied to the entire text; it cannot be applied to just part of the text. However, the box, rounded box and shading patterns can be applied to just part of the text as explained in Undl/Frm (UNDERLINE/FRAME) KEY on pages 107 and 108.

## OPERATION

### TO CHANGE THE FRAME OR SHADING FOR THE ENTIRE TEXT:

- 1 Press  .
- 2 Press  or  until the setting for the GROBAL FRAME function is highlighted.
- 3 Press  or  until the frame that you want to use is displayed.
- 4 Press  . The text is displayed with the selected frame.

# FRAME COLOR FUNCTION

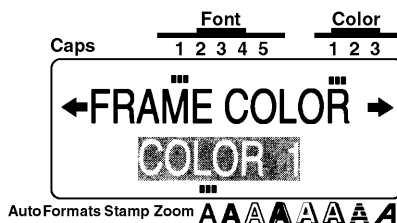

## BACKGROUND

You can choose which of the three ink colors will be used to print any underline, frame, strike-out or shading in your text during color printing. For more details on color printing, refer to *COLOR PRINT FUNCTION* on pages 123 to 124.

The default setting is COLOR 1.

**ⓘ** Before printing with the *COLOR PRINT* function, be sure the *FRAME COLOR* function has been set.

*The color selected with the FRAME COLOR function will be applied all underlines, frames, strike-outs or shadings in the text; it cannot be applied to just part of the text. If you have not added an underline, frame, strike-out or shading to your text, the setting selected for this function is ignored during color printing.*

## OPERATION

### TO CHANGE THE UNDERLINE, FRAME, STRIKE-OUT AND SHADING COLOR:

- 1 Press .
- 2 Press or until the setting for the FRAME COLOR function is highlighted.
- 3 Press or until the color setting that you want to use is displayed.
- 4 Press . All underlines, frames, strike-outs and shading are given the selected color setting.

## SAMPLES

The *FRAME COLOR* function can be used to create labels like those shown below.



# STYLE COLOR FUNCTION

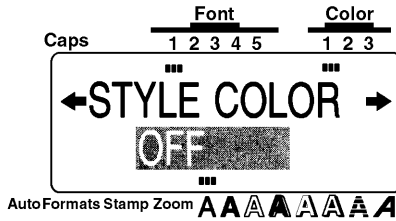

## BACKGROUND

When using the COLOR PRINT function to print text formatted in any style other than A (normal) or **A** (bold), *A* (italic), or **A** & *A* (italic & bold), you can choose a fill-in color for the parts of the characters that are normally left blank as shown under *SAMPLES*. For more details on color printing, refer to *COLOR PRINT FUNCTION* on pages 123 to 124.

The default setting is OFF.

 Before printing with the COLOR PRINT function, be sure the STYLE COLOR function has been set.







The STYLE COLOR function can only be applied to the entire text it; it cannot be applied to just part of the text.

If only the A (normal), **A** (bold), *A* (italic) or **A** & *A* (italic & bold) style settings are used in the text, the setting selected for this function is ignored during color printing.

If this function and the text are set to the same color, this function's setting is ignored during color printing.

## OPERATION

### TO CHANGE THE CHARACTER FILL - IN COLOR:

- 1 Press  .
- 2 Press  or  until the setting for the STYLE COLOR function is highlighted.
- 3 Press  or  until the setting that you want to use is displayed.
- 4 Press  . The parts of the characters that are normally left blank are given the selected color setting.

## SAMPLES

The **STYLE COLOR** function can be used with styles other than normal, bold, italic, and italic & bold. (In the samples below, the **STYLE COLOR** function was set to fill in the characters with red.)

A (outline)

ABC

A (outline

+ shadow)

ABC

A (solid)

ABC

A (striped)

ABC

A (shadow)

ABC

# LENGTH FUNCTION

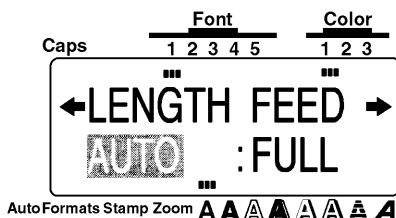

## BACKGROUND

The length of the label can be set in two different ways. With the AUTO length setting, the machine compares your entered text with the size of the installed tape and automatically adjust the label length to fit the text. However, if you want to select the label length, it can be set between 1.5" (3.8 cm) and 11.3" (28.7 cm).

The default setting is AUTO.

**⚠** *The LENGTH function can only be applied to the entire text; it cannot be applied to just part of the text.*

*If the text will not fit within the length that is set, the error message "TOO LONG!" will appear.*

## OPERATION

### TO CHANGE THE LABEL LENGTH:

- 1 Press .
- 2 Press or until the setting for the LENGTH function is highlighted.
- 3 Press or until that you want to use is displayed. Pressing either key once will change the length by 0.1" (0.1 cm if centimeters are displayed). If a key is held down, the length will continue changing in 1" (1.0 cm) step until the key is released.
- 4 Press . The label is given the selected length setting.



# FEED (TAPE FEED) FUNCTION

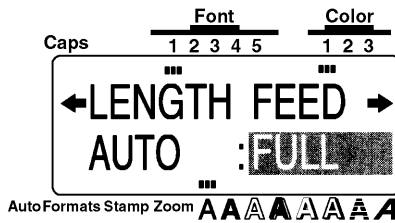

## BACKGROUND

The FEED function allows you to select the size of the margins on the left and right side of your test.

The default setting is FULL; however, three other settings are also available.

FULL (1" (25 mm))

NONE (1/6" (4 mm))

NERROW (1/3" (8 mm))

MEDIUM (1/2" (12 mm))







 The FEED function can only be applied to the entire text; it cannot be applied to just part of the text.

Since reducing the tape feed may decrease bar code readability, the FULL tape feed setting is recommended when the text contains bar codes

If an instant-lettering (rub-on transfer) or an iron-on transfer tape cassette is installed, the text will be printed with the FULL setting (1" (25 mm)-margins), even if a different setting was selected.

## OPERATION

### TO CHANGE THE TAPE FEED WIDTH:

- 1 Press  .
- 2 Press  or  until the setting for the FEED function is highlighted.
- 3 Press  or  until the tape feed width that you want to use is displayed.
- 4 Press  .

# H.ALI (HORIZONTAL ALIGNMENT) FUNCTION

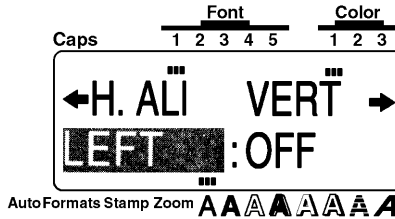

## BACKGROUND

You can choose to align the text in one of four ways.

The default setting is LEFT; however, three other settings are also available.







LEFT  
CENTER  
RIGHT  
JUSTIFY

 The H.ALI (horizontal alignment) function can only be applied to the entire text; it cannot be applied to just part of the text.

If the label length for text containing multiple blocks has been set with the LENGTH function and its horizontal alignment has been set to JUSTIFY, the spaces between the blocks are adjusted so that the text spreads out evenly along the label.

## OPERATION

TO CHANGE THE HORIZONTAL ALIGNMENT OF THE TEXT:

- 1 Press .
- 2 Press  or  until the setting for the H.ALI function is highlighted.
- 3 Press  or  until the alignment setting that you want to use is displayed.
- 4 Press . The text is displayed with the selected alignment.

## SAMPLES

LEFT  
ABC  
DEFGHIJ  
KLMNOP  
Q

CENTER  
ABC  
DEFGHIJ  
KLMNOP  
Q

RIGHT  
ABC  
DEFGHIJ  
KLMNOP  
Q

JUSTIFY  
A B C  
DEFGHIJ  
KLMNOP  
Q

# VERT (VERTICAL PRINTING) FUNCTION

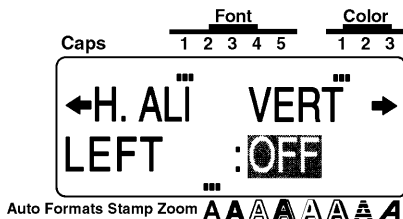

## BACKGROUND

The text that you enter can be printed vertically along the length of your label. The default setting is OFF.

- ✎ The VERT (vertical printing) function can only be applied to the entire text; it cannot be applied to just part of the text.

## OPERATION

TO CHANGE THE VERTICAL PRINTING SETTING:

- 1 Press .
- 2 Press or until the setting for the VERT function is highlighted.
- 3 Press or until the vertical printing setting that you want to use is displayed.
- 4 Press . The text is displayed according to the selected vertical printing setting.

## SAMPLES

**DISPLAY**

Auto Formats Stamp Zoom

Auto Formats Stamp Zoom

**LABEL**

# MIRROR (MIRROR PRINTING) FUNCTION

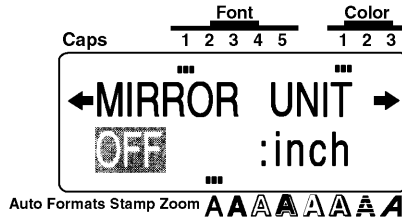

## BACKGROUND

With this function, you can print your text in reverse so that it can be used from the adhesive side of the tape. If there labels are printed on clear tape and affixed to glass or any other clear material, the text can be read correctly from the opposite side.







The default setting is OFF.

⚠ When the MIRROR function is set to ON, print the text on clear tape.

The MIRROR (mirror printing) function can only be applied to the entire text; it cannot be applied to just part of the text.

## OPERATION

### TO CHANGE THE MIRROR PRINTING SETTING:

- 1 Press .
- 2 Press  or  until the setting for the MIRROR function is highlighted.
- 3 Press  or  until the mirror printing setting that you want to use is displayed.
- 4 Press .

## SAMPLES

### DISPLAY

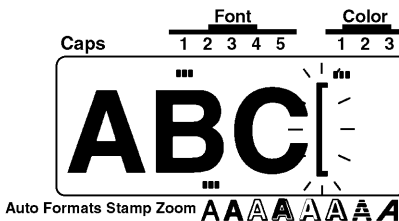

### LABEL



# UNIT FUNCTION

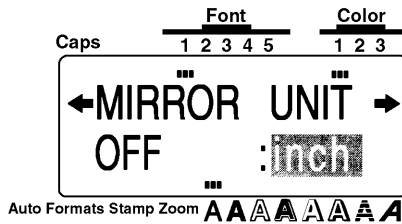

## BACKGROUND







The measurements on the display are shown in either inches (inch) or centimeters (cm). With this function, you can choose which units are used when displaying measurements.

The default units setting is inch.

 *This setting can only be applied to all of the measurements; it cannot be applied to just part of them.*

## OPERATION



### TO CHANGE THE UNITS OF THE MEASUREMENTS:

- 1 Press  .
- 2 Press  or  until the setting for the UNIT function is highlighted.
- 3 Press  or  until the unit setting that you want to use is displayed.
- 4 Press  . All measurements will be displayed in the selected units.

# Print KEY AND Feed & Tape Cut KEY



## BACKGROUND

After you have entered your text and chosen all of the format settings that you want to use, you can print the label. After the label is printed, it will automatically be cut if the A.CUT parameter of the **Special Print** function is set ON.

The **Feed & ** key (  ) is used to feed out 1" (25 mm) of tape and automatically cut it.

Press this key to feed out any leftover printed tape after pressing  to quit printing.

## OPERATION

- To print a label, press . The message "WORKING" appears in the display just before printing begins, then "COPIES 1/1" appears if just one label is being printed.
    - ☛ *If the COPIES parameter of the **Special Print** function is set to any number other than 1 when printing more than one copy of the label, the number of each copy is displayed while each label is being printed.*
- To quit printing, press .
- To feed out 1" (25 mm) of tape and cut it, press .









# COLOR PRINT FUNCTION



## BACKGROUND

With the COLOR PRINT function, you can create colorful labels which are printed with up to three ink colors. By giving certain parts of your text a different color, you can make them more noticeable.



## OPERATION

### TO PRINT A LABEL WITH THE COLOR PRINT FUNCTION:

- 1 Decide which ink color you want to use as COLOR1, COLOR2 and COLOR3.
  - ☞ Before printing with the COLOR PRINT function, use  to select the color setting for each part of your label and press  to set the FRAME COLOR and the STYLE COLOR functions. (For more details, refer to pages 113 through 115.)
- 2 Insert the ink cassette for the first color (the color that will be used to print the parts of the text set to COLOR1) into a color printing tape cassette, then insert them into the tape compartment.
  - ☞ Make sure that the entire back of the cassette touches the bottom of the tape compartment.
- 3 Press  to prepare for color printing.
- 4 Press . The setting for the COLOR PRINT function appears.
  - ☞ This setting appears only if at least two color settings have been selected and if color printing ink and tape cassettes have been installed.
  - The parameter settings selected for the **Special Print** function are ignored during color printing.
- 5 Press  or  until the ON setting appears, then press . The message "INSERT COLOR1" is displayed.
  - ☞ Before printing, be sure that there is enough tape in the tape cassette, otherwise the label will not be printed correctly.
  - To quit the COLOR PRINT function at any time, press .
  - If any color setting (COLOR1, COLOR2 or COLOR3) is not set, that color setting's messages are skipped and the message for the next color is displayed.

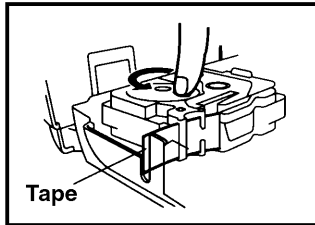
- 6 Open the tape compartment cover and check that the first ink cassette is installed, then close the cover and press . The message "WORKING" appears in the display just before printing begins, then "COPIES COLOR1" appears while the text set to COLOR1 is printed. When printing is finished, the message "REMOVE INK RIBBON" is displayed.
- 7 Open the tape compartment cover and remove the ink ribbon, then press . The message "REWIND TAPE & INSERT COLOR2" is displayed.
- 8 Rewind the tape roll using your finger to turn it anti-clockwise until the tape end aligns with the tape cutter, insert the second ink cassette, then close the cover and press . The message "WORKING", and then "COPIES COLOR2" appears while the text set to "COLOR2" is printed. When printing is finished, the message "REMOVE INK RIBBON" is displayed.



- 9 Open the tape compartment cover and remove the ink ribbon, then press . The message "REWIND TAPE & INSERT COLOR3" is displayed.
- 10 Rewind the tape roll using your finger to turn it anti-clockwise until the tape end aligns with the tape cutter, insert the third ink cassette, then close the cover and press . The message "WORKING" and then "COPIES COLOR3" appears while the text set to COLOR3 is printed.
- 11 After the label is automatically cut off, use scissors to cut along the two dots printed on the label so that the margins will be equal.

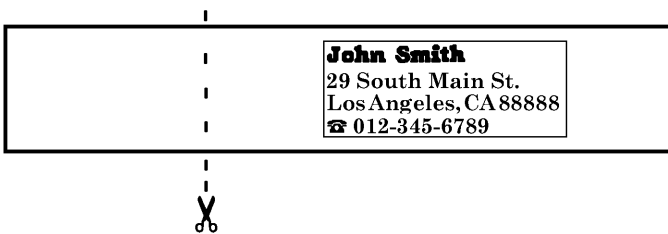



# Stamp FUNCTION

## BACKGROUND

The **Stamp** function allows you to quickly and easily create your own customized stamp. Use this function to automatically center the text and adjust the label length and margins to perfectly fit the pre-inked stamp film holders. Since the stamp holder is reusable, make new stamps by just replacing the stamp film in the holder.



 *Keep the stamp film holder out of the reach of children.*







*Avoid getting ink your eyes or mouth. If ink comes in contact with your eyes or gets in your mouth, immediately wash your eyes or mouth with fresh water for several minutes and consult a doctor.*

*Keep ink off skin, clothes and important pages. Immediately use soap to wash skin that has come in contact with ink. Even washing may not remove all ink.*

## OPERATION

### TO MAKE A STAMP:

- 1 Insert a stamp film cassette with the desired size into the tape compartment.
- 2 Hold down  and press . The **Stamp** indicator lights up and the STAMP FORMAT setting for the installed tape cassette is displayed. If a 3/4" (18-mm)-wide stamp film cassette is installed, STAMP M appears below the STAMP FORMAT setting; if a 1" (24-mm)-wide stamp film cassette is installed, STAMP L appears below the STAMP FORMAT setting.

 *If text has already been entered in the display, the message "OK TO CLEAR TEXT BUFFER?" appears. Press  to delete the text.*
- 3 Type in and format your text.
- 4 Press .
- 5 Press  or  until the SELECT TAPE setting is set to FOR STAMP.
- 6 Press . The message "WORKING" appears in the display just before printing begins, then "COPY STAMP TAPE" is displayed while your text is cut from the stamp film. Afterwards, you can choose either the EDIT STAMP setting to edit the stamp text, or the FINISH STAMP setting to return the display to WYSIWYG mode (the **Stamp** indicator goes off.)

 *When printing large characters or at low temperatures, the stamp quality can be improved if the AC adaptor is connected.*

- 7 After the stamp film is cut off, remove the backing paper.

### Affixing the stamp film

- 8 Remove the frame from around the stamp holder ink pad, one end at a time, then remove the protective seal covering the ink pad.

 *If the stamp holder already contains a stamp film, hold the stamp over a piece of scrap paper and remove the stamp frame by pulling it off, one end at a time. Then, slowly peel off the stamp film. Be careful not to splatter the ink.*

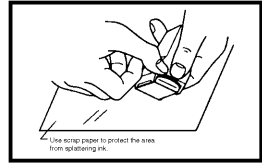

- 9 With the glossy side of the stamp film facing up, align one end of the stamp film with the slit in the side of the stamp holder.

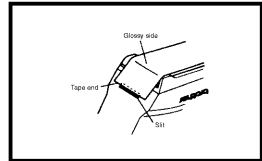

- 10 Hold the end of the stamp film in place with your thumb, then pass the stamp film through the guides while pulling it tight.

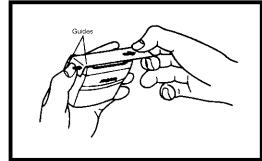

- 11 Fold the other end of the stamp film over the other side of the stamp holder and hold it in place with your finger.

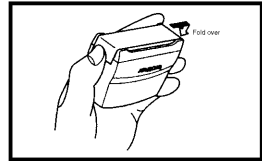

- 12 Fit the frame over the stamp film, then push the frame into place.

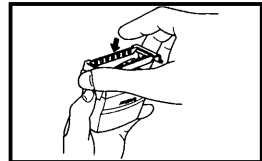

- 13 Insert the stamp holder straight into the cap.





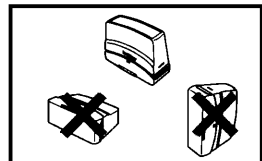
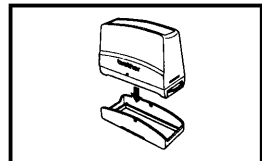

 *Be sure that the stamp is correctly covered by the cap in order to prevent ink spills.*

*When the stamp is not being used, cover it firmly with the cap and always store it standing up with the stamp facing downward. Do not leave the stamp laying on its side or leaning.*

*Store the stamp film holder and stamp film cassettes in a location where they are not exposed to high temperatures, high humidity or direct sunlight.*



## Printing an identification label for the stamp holder

- 14 Press  or  until the EDIT STAMP setting, which was displayed after the stamp was made, is selected.
- 15 Press .
- 16 Insert a TZ tape cassette into the tape compartment.
  - ☛ Use 1/2" (12-mm)-wide tape to make an identification label for a stamp when the STAMP FORMAT is set to STAMP M and use 3/4" (18-mm)-wide tape to make a label for a stamp when the STAMP FORMAT is set to STAMP L.
- 17 Press .
- 18 Press  or  until the SELECT TAPE setting is set to FOR LABEL.
- 19 Press . The message "WORKING" appears in the display just before printing begins, then "COPY LABEL TAPE" is displayed while your identification label is printed.
- 20 After the label is cut off, affix it to the holder so that its bottom edge is on the same side of the stamp holder as the raised logo.

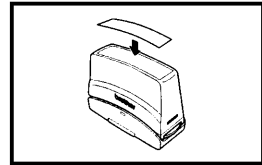

## Stamping

Since the length of time and force that the stamp holder should be held down depends on the amount of ink in the holder, first practice stamping on a piece of scrap paper. To stamp, place the stamp over the desired position and press straight down on the stamp holder to force ink through the stamp film.

You can expect to use a stamp film holder approximately 300 to 500 times, although some ink is lost when the stamp film is changed. The actual life of the stamp film holder may be slightly shorter depending on the size and thickness of the characters, whether a shading pattern is used, etc.

☛ *After stamping, wait until the ink has completely dried before touching it in order to prevent smearing.*

*If the stamp holder is not pressed straight down, the stamp may be blurred.*

*Do not press the stamp holder down too forcefully.*

*Do not stamp on wet, sticky, rough or uneven surfaces. Only stamp on paper. The ink will not dry if plastic overhead projector transparencies and other ink-impermeable objects are stamped.*

*If the stamp made with a new stamp film is faint or incomplete, even after forcefully pressing down the stamp holder for up to 30 seconds, replace the stamp holder with a new one. Do not try to refill the stamp holder.*

# Special Print FUNCTION

## BACKGROUND

The **Special Print** function allows you to set the number of copies of the label that will be printed, set whether the machine will automatically cut off each label, and turn the split printing function on and off.

Parameters	Settings
COPIES (number of label copies that will be printed)	1 to 99
A.CUT (automatically cuts off each label after printing)	ON, OFF
SPLIT (splits the label lengthwise and prints it as two labels)	ON, OFF

 When the **SPLIT** parameter is set to **ON**, the **COPIES** parameter is ignored and only one copy of the label will be printed.

The settings selected for these three parameters are ignored during color printing.

## OPERATION

### TO CHANGE A PARAMETER SETTING OF THE SPECIAL PRINT FUNCTION:

- 1 Hold down  and press .
- 2 Press  or  until the parameter settings that you want to change is highlighted.
- 3 Press  or  until the desired setting is displayed.

 When setting the **COPIES** parameter, pressing either key once will change the setting by 1. However, if either of these keys are hold down, the setting will continue changing in steps of 5 until the key is released.

To select the default setting, press .

To change all parameters to their default settings, hold down  and press .

- 4 Repeat step 2 and 3 until all parameters are set as you wish.
- 5 Press . The labels are printed with the selected parameter settings.

 To set the parameters without printing the label, press .

**Display**

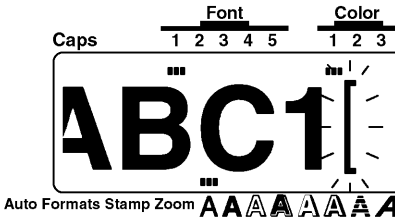

**Default Print Settings**

COPIES: 1  
 A.CUT: ON  
 SPLIT: OFF

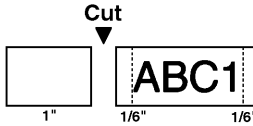

**Custom Settings**

**Example1**  
 COPIES: 2  
 A.CUT: OFF  
 SPLIT: OFF

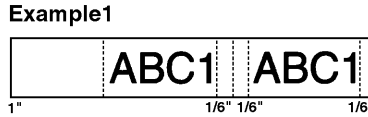

**Example2**  
 COPIES: 1  
 A.CUT: ON  
 SPLIT: ON

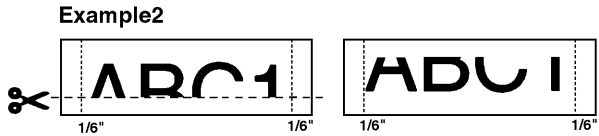

If the SPLIT parameter is set to ON, labels like those shown above are printed. Cut off the blank space on the bottom of the first label, then put the top and bottom parts together so that there is no blank in the characters.



☞ If the labels are printed on transparent tape, they can be put together without cutting the blank space off.

# Seq. Numbering FUNCTION

## BACKGROUND





The **Seq. Numbering** (Sequential numbering) function can be used to print many copies of the same text while increasing certain characters (letters, numbers or a bar code's data) after each label is printed. This type of automatic incrementation is very useful when printing serial number labels, production control labels or other labels requiring ascending codes.

☛ *Only one numbering field can be selected from any text.*



*If you include a non-alphanumeric character such as a symbol in the numbering field, only the letters and numbers in the numbering field will be increased when the labels are printed, or just one label will be printed if the field only contains a non-alphanumeric character.*



## OPERATION

### TO PRINT LABELS WITH CHARACTERS IN THE NUMBERING FIELD:

1 Press , ,  or  to move the cursor to the left of the first character (number or letter) you want to include in the field.

2 Hold down  and press . The message "SELECT FIELD!" is displayed, then the first character is highlighted.

☛ *To quit the **Seq. Numbering** function at any time, press  (or hold down  and press ).*



3 Press  or  until all the characters to be included in the numbering field are highlighted.

☛ *The maximum number of characters in a numbering field is five. If you try to choose more than five characters, the error message "WRONG SELECT" will appear.*

*A numbering field must be located entirely within line of text of a single block. If you try to include text from two different lines or two different blocks in the numbering field, the error message "INVAL. CHARS!" will appear.*

*The numbering field cannot contain characters with different format settings. If you try to choose characters with different format settings, the error message "WRONG SELECT" will appear.*

4 Press . The NUMBER setting is displayed.

5 Press  or  until the number of labels that you wish to print is displayed.

6 Press  to print the labels. The message "WORKING" appears in the display just before printing begins, then the number of each copy is displayed while it is being printed.





 Letters and numbers increase as shown below.

0 → 1 → ... 9 → 0 → ...  
A → B → ... Z → A → ...  
a → b → ... z → a → ...  
A0 → A1 → ... A9 → B0 → ...

Spaces (shown as underlines (  ) in the examples below) can be used to adjust the space between characters or to control the number of digits that are printed:



  0 →   1 → ... 99 →   0 → ...  
  A →   B → ...   Z → AA → ...

### TO PRINT LABELS WITH A BAR CODE IN THE NUMBERING FIELD:

1 Press , ,  or  to move the cursor immediately to the left or in the middle of the bar code mark which you want to select as the numbering field.

2 Hold down  and . The NUMBER setting is displayed.

 If the numbering field consists of a bar code, no additional characters can be selected.

3 Press  or  until the number of labels that you wish to print is displayed.

4 Press  to print the labels. The message "WORKING" appears in the display just before printing begins, then the number of each copy is displayed while it is being printed.

**EXAMPLE**

To print three labels with seat numbers 1Y, 1Z and 2A:

- 1 Position the cursor to the left of "1!".

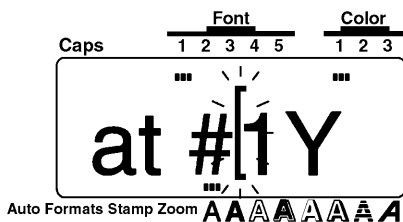

- 2 Hold down **Code** and press **Seq. Numbering**.

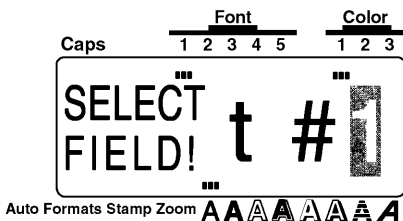

- 3 Press **Right Arrow** until the "Y" is also selected.

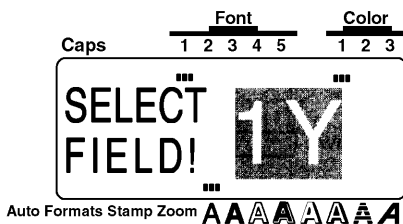

- 4 Press **New black**.

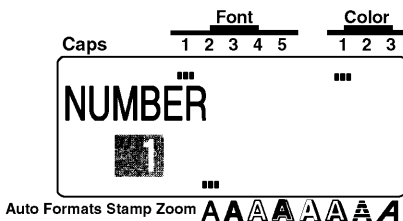

- 5 Press **Home** until NUMBER is set to 3.

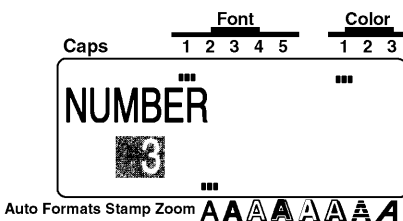



6 Press  .

Font Color  
Caps 1 2 3 4 5 1 2 3  
WORKING

Auto Formats Stamp Zoom 

Font Color  
Caps 1 2 3 4 5 1 2 3  
WORKING

Auto Formats Stamp Zoom 

Font Color  
Caps 1 2 3 4 5 1 2 3  
WORKING

Auto Formats Stamp Zoom 

Font Color  
Caps 1 2 3 4 5 1 2 3  
at #2B

Auto Formats Stamp Zoom 

Seat #1Y

Seat #1Z

Seat #2A



Font Color  
Caps 1 2 3 4 5 1 2 3  
COPIES  
1 / 3

Auto Formats Stamp Zoom 

Font Color  
Caps 1 2 3 4 5 1 2 3  
COPIES  
2 / 3



Auto Formats Stamp Zoom 

Font Color  
Caps 1 2 3 4 5 1 2 3  
COPIES  
3 / 3

Auto Formats Stamp Zoom 

# Store, Recall AND M.Del KEYS

## BACKGROUND



You can use the memory to store frequently used text. These text files remain in the memory, even after all characters are removed from the display with the **Clear** function (by holding down  and pressing ).





When each file is stored, it is given a number so that it can be recalled more easily. Up to 100 files or about 3,000 characters on the P-touch 550 (or 1,000 characters on the P-touch 530) can be stored in the memory.



Since a copy of the stored text file is recalled when the **Recall** function is used, the text can be edited or printed without changing the originally stored file. When a file is no longer needed or more space is necessary, the **M.Del** function can be used to delete it.

## OPERATION



### TO STORE A TEXT FILE IN THE MEMORY:

- 1 Hold down  and press .

 To quit the **Store** function at any time without storing the text, press  (or hold down  and press ).

- 2 Press  or  until the file number where you want to store the text is displayed.

 The number for files that are still empty are highlighted when they are displayed. The number for files that already contain text are not highlighted and their text is shown on the display.

To change the file number by ten, hold down  while pressing  or .

- 3 Press . The text is stored under the selected file number.

 If a file is already stored under the selected file number, the message "OVERWRITE?" appears and you must choose whether or not to overwrite it (i.e., delete it from the memory and store the new one).

### Overwriting the stored file with the new one

- 4 Press . The previously stored file will be deleted and the new one will be stored under the selected number.

 To go back and choose another file number without overwriting the text file, press

.

## TO RECALL A TEXT FILE FROM THE MEMORY:



- 1 Hold down  and press . The number and the first characters of the most recently stored or recalled text file are displayed.  
*☛ To quit the **Recall** function at any time without recalling text, press  (or hold down  and press ).*
- 2 Press  or  until the file that you want to recall is displayed.  
*☛ To scan through the selected text file, press  or .*
- 3 Press . The text stored under the selected file number is displayed.  
*☛ If text was entered in the display before the **Recall** function was started, the displayed text is deleted when the recalled text is displayed.*

## TO DELETE A TEXT FILE FROM THE MEMORY:

- 1 Hold down  and press . The number and the first characters of the most recently stored or recalled text file are displayed.  
*☛ To quit the **M.Del** function at any time without deleting a text file, press  (or hold down  and press ).*
- 2 Press  or  until the file that you want to delete is displayed.  
*☛ To scan through the selected text file, press  or .*  
*To select more than one file, select each file by displaying it, then pressing  to highlight the number. To cancel the selection of the file, press  until the number is no longer highlighted. (If no files are selected by pressing , the file that is displayed is the file that will be deleted).*  
*To select all the files in the memory, hold down  and press . To cancel the selection of all files in the memory, hold down  and press  .*
- 3 Press . Either the message "OK TO CLEAR?" or "CLEAR ALL?" is displayed.
- 4 Press . The selected files are deleted.

**EXAMPLE**

To store text under file number 8:

1 Hold down  and press .

2 Press  or  until file number 8 is displayed.

3 Press .

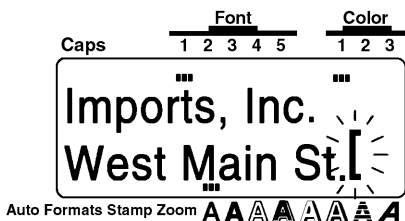
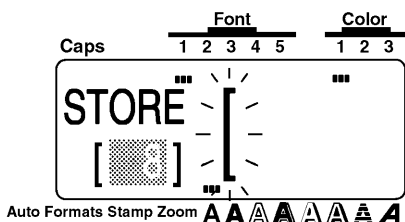
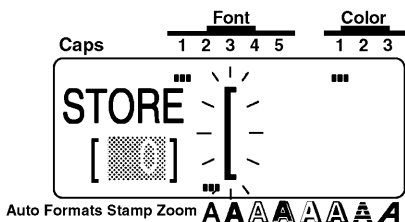
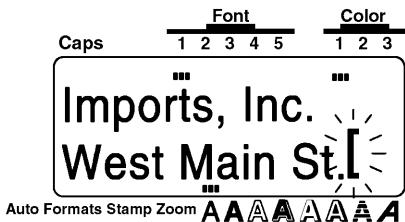

**To recall text from file number 4:**

④ Press **Code** and press **Recall** 8.

Caps      Font      Color  
 1 2 3 4 5      1 2 3



Auto Formats Stamp Zoom **A A A A A A A A**

⑤ Press **Home** or **End** until file number 4 is displayed.

Caps      Font      Color  
 1 2 3 4 5      1 2 3



Auto Formats Stamp Zoom **A A A A A A A A**

⑥ Press **New Block** to replace the display text with the text from the recalled file.

Caps      Font      Color  
 1 2 3 4 5      1 2 3

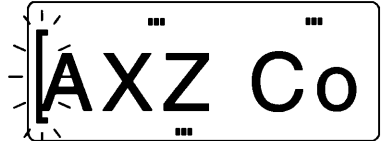

Auto Formats Stamp Zoom **A A A A A A A A**

**To delete the text from file number 8:**

⑦ Hold down **Code** and press **Mod** 5.

Caps      Font      Color  
 1 2 3 4 5      1 2 3



Auto Formats Stamp Zoom **A A A A A A A A**

⑧ Press **Home** or **End** until file number 8 is displayed.

Caps      Font      Color  
 1 2 3 4 5      1 2 3



Auto Formats Stamp Zoom **A A A A A A A A**

9 Press  .

Caps      Font      Color  
1 2 3 4 5      1 2 3

OK TO [Imports,  
CLEAR? West Ma

Auto Formats Stamp Zoom **A A A A A A A**









10 Press  .



























Caps      Font      Color  
1 2 3 4 5      1 2 3

[AXZ Co

Auto Formats Stamp Zoom **A A A A A A A**







# ERROR MESSAGE LIST



ERROR MESSAGE	CAUSE	REMEDY
4 DIGIT MAIN.	<ul style="list-style-type: none"> <li>This message appears when less than the minimum four digits are entered as bar code data.</li> </ul>	<ul style="list-style-type: none"> <li>Enter a minimum of four digits before pressing .</li> </ul>
5 BARS LIMIT! 5 BARS LIMIT!	<ul style="list-style-type: none"> <li>This message appears if five bar code already exist when you hold down  and press .</li> </ul>	<ul style="list-style-type: none"> <li>Limit the number of the bar codes in the text to five.</li> </ul>
5 BLOCK LIMIT!	<ul style="list-style-type: none"> <li>This message appears if five blocks already exist when you hold down  and press .</li> </ul>	<ul style="list-style-type: none"> <li>Limit the number of blocks in the text to five.</li> </ul>
7 LINE LIMIT!	<ul style="list-style-type: none"> <li>This message appears if seven lines have already been entered in a block of text when you press , causing the block to exceed the seven-line limit.</li> <li>This message appears if you press  to join two blocks, causing the block to exceed the seven-line limit.</li> </ul>	<ul style="list-style-type: none"> <li>Limit the number of lines in the text block to seven or hold down  and press  before entering the text.</li> <li>Adjust the number of lines so the block will not have more than seven lines.</li> </ul>
BATTERIES WEAK	<ul style="list-style-type: none"> <li>This message appears when the installed alkaline batteries become weak.</li> </ul>	<ul style="list-style-type: none"> <li>Replace the batteries or use the AC adaptor.</li> </ul>

ERROR MESSAGE	CAUSE	REMEDY
<p>BUFFER ENPTY!  BUFFER EMPTY!  BUFFER EMPTY!</p>	<ul style="list-style-type: none"> <li>This message appears if no text has been entered when you press  or , or hold down  and press , ,  or .</li> </ul>	<ul style="list-style-type: none"> <li>Enter text before pressing  or , or holding down  and pressing , ,  or .</li> </ul>
<p>BUFFER FULL!  BUFFER FULL!  BUFFER FULL!</p>	<ul style="list-style-type: none"> <li>This message appears if enough text has been entered to fill the buffer when you try to add a character, a space, a new line or new block.</li> <li>This message appears if enough text has been entered to fill the buffer when you press , , , , , or .</li> <li>This message appears if enough text has been entered to fill the buffer when you press  to add a symbol, accented character or bar code.</li> </ul>	<ul style="list-style-type: none"> <li>Delete some text so that more can be entered.</li> <li>Press any key, then delete some of the text before trying to change the text format.</li> <li>Press any key, then delete some of the text before trying to add a symbol, accented chracter or bar code.</li> </ul>
<p>CAN'T HERE  CAN'T HERE  CAN'T HERE</p>	<ul style="list-style-type: none"> <li>This message appears if the cursor is located in a bar code mark when you try to add a character or symbol, a space a new line or a new block.</li> <li>This message appears if the cursor is located in a bar code mark when you press , , , ,  or .</li> </ul>	<ul style="list-style-type: none"> <li>Move the cursor or delete the bar code before entering the chracter, symbol, space, new line or new block.</li> <li>Move the cursor or delete the bar code before trying to change the text format (font, size, width, style, underline/ frame, or color).</li> </ul>





ERROR MESSAGE	CAUSE	REMEDY
CHANGE ADAPTOR	<ul style="list-style-type: none"> <li>This message appears if a high-voltage adaptor is being used.</li> </ul>	<ul style="list-style-type: none"> <li>Remove the high-voltage adaptor and connect the optional 7.0V 1.2A AC adaptor.</li> </ul>
CLOSE THE COVER	<ul style="list-style-type: none"> <li>This message appears if the tape compartment cover is open.</li> </ul>	<ul style="list-style-type: none"> <li>Close the compartment cover.</li> </ul>
CUTTER ERROR!	<ul style="list-style-type: none"> <li>This message appears if the cutter did not operate correctly while cutting the tape.</li> </ul>	<ul style="list-style-type: none"> <li>Press any key to move the cutter to its correct position. If the cutter still does not operate correctly, contact your service representative.</li> </ul>
ERROR! UL/FRM	<ul style="list-style-type: none"> <li>This message appears if you try to underline or frame more than 35 characters.</li> </ul>	<ul style="list-style-type: none"> <li>Reduce the number of characters that you are trying to underline or frame.</li> </ul>
INPUT ABCD AT BEGIN & END	<ul style="list-style-type: none"> <li>This message appears if a letter between A and D has not been entered at the beginning and end of a bar code when the CODABAR protocol is used in Bar code mode.</li> </ul>	<ul style="list-style-type: none"> <li>Enter a letter between A and D at the beginning and end of the bar code.</li> </ul>
INPUT WHOLE CODE	<ul style="list-style-type: none"> <li>This message appears if the set number of digits are not entered in the bar code data.</li> </ul>	<ul style="list-style-type: none"> <li>Input the correct number of digits or change the number of digits set in the bar code parameters.</li> </ul>
INSTALL COLOR TAPE!	<ul style="list-style-type: none"> <li>This message appears if a color printing cassette is not installed when you begin assigning the color settings or during color printing.</li> </ul>	<ul style="list-style-type: none"> <li>Install a color printing ink ribbon and tape cassette.</li> </ul>
INSTALL ATAMP TAPE!	<ul style="list-style-type: none"> <li>This message appears if a stamp film cassette is not installed when you hold down <input type="text" value="Code"/> and press <input type="text" value="Auto Format Stamp"/>.</li> </ul>	<ul style="list-style-type: none"> <li>Install a stamp film cassette.</li> </ul>

ERROR MESSAGE	CAUSE	REMEDY
<p>INVAL. CHRS!</p>	<ul style="list-style-type: none"> <li>• This message appears if characters in different lines or blocks are selected as the numbering field.</li> <li>• This message appears if a bar code is selected together with other characters as a numbering field.</li> </ul>	<ul style="list-style-type: none"> <li>• Adjust the numbering field so that it only contains characters within a single line of a single text block.</li> <li>• Select either the bar code or the characters alone as the numbering field.</li> </ul>
<p>LENGTH LIMIT!</p>	<ul style="list-style-type: none"> <li>• This message appears if you try to add a character, symbol, bar code, space, return or new block, causing the text to exceed the one-meter limit.</li> <li>• This message appears if you turn on the power or try to print using the <b>Seq. Numbering</b> function, causing the entered text to exceed the one-meter limit.</li> <li>• This message appears if you try to recall a text file, causing the text to exceed the one-meter limit.</li> <li>• This message appears if you press  after setting the label formats using the <b>Format</b> key or setting the text formats by pressing  ,  ,  ,  ,  , or  , causing the text to exceed the one-meter limit.</li> </ul>	<ul style="list-style-type: none"> <li>• Press any key, then delete some of the text or reduce the character size.</li> <li>• Press any key, then delete some of the text or reduce the character size.</li> <li>• Press any key, then delete some of the text before recalling the text file.</li> <li>• Press any key, then delete some of the text before setting the label formats or text formats.</li> </ul>
<p>LIMIT 2!</p>	<ul style="list-style-type: none"> <li>• This message appears if you try to overlap more than two underlines, frames or shadings.</li> </ul>	<ul style="list-style-type: none"> <li>• Reduce the number of underlines, frames or shadings that you are trying to set.</li> </ul>

ERROR MESSAGE	CAUSE	REMEDY
LINE LIMIT!	<ul style="list-style-type: none"> <li>• This message appears if you try to increase the number of lines in the text, causing them to exceed the maximum possible for the installed tape.</li> <li>• This message appears if you press  to add a new line or press  to join two blocks, causing the number of lines in a block to exceed the maximum possible for the installed tape.</li> </ul>	<ul style="list-style-type: none"> <li>• Reduce the number of line or install a wider tape.</li> <li>• Adjust the number of lines so the block will not have more than the maximum possible.</li> </ul>
MEMORY FULL!	<ul style="list-style-type: none"> <li>• This message appears if you try to store a message that is too large to fit in the available memory space (maximum of 3000 characters on the P-touch 550 and 1000 characters on the P-touch 530).</li> </ul>	<ul style="list-style-type: none"> <li>• Delete an unwanted file to make room for the new one.</li> </ul>
NO FILES!	<ul style="list-style-type: none"> <li>• This message appears if no text files are stored in the memory when you try to recall or delete one.</li> </ul>	<ul style="list-style-type: none"> <li>• Store a text file before trying to recall or delete one.</li> </ul>
NO TAPE!	<ul style="list-style-type: none"> <li>• This message appears if no tape cassette is installed when you try to print a label or feed and cut the tape.</li> </ul>	<ul style="list-style-type: none"> <li>• Install a tape cassette and try again.</li> </ul>
OPEN THE COVER!	<ul style="list-style-type: none"> <li>• This message appears if the compartment cover is closed when a message appears instructing you to rewind the tape during color printing.</li> </ul>	<ul style="list-style-type: none"> <li>• Open the compartment cover and continue following the color printing directions.</li> </ul>
RAM PROBLEM!	<ul style="list-style-type: none"> <li>• This message appears if there is a problem with the machine's random access memory.</li> </ul>	<ul style="list-style-type: none"> <li>• Contact your service representative.</li> </ul>
REPLACE BATTERIES!	<ul style="list-style-type: none"> <li>• This message appears when the installed alkaline batteries are about to run out.</li> </ul>	<ul style="list-style-type: none"> <li>• Replace the batteries or use the AC adaptor.</li> </ul>

ERROR MESSAGE	CAUSE	REMEDY
ROM PROBLEM!	<ul style="list-style-type: none"> <li>This message appears if there is a problem with the machine's read only memory.</li> </ul>	<ul style="list-style-type: none"> <li>Contact your service representative.</li> </ul>
SET 1 1/2" !	<ul style="list-style-type: none"> <li>This message appears if a 1 1/2"(36-mm)-wide tape cassette is not installed when a template for 1 1/2"(36-mm)-wide tape is selected.</li> </ul>	<ul style="list-style-type: none"> <li>Install a 1 1/2"(36-mm)-wide tape cassette.</li> </ul>
SET 1" !	<ul style="list-style-type: none"> <li>This message appears if a 1"(24-mm)-wide tape cassette is not installed when a template for 1"(24-mm)-wide tape is selected.</li> </ul>	<ul style="list-style-type: none"> <li>Install a 1"(24-mm)-wide tape cassette.</li> </ul>
SET 3/4" !	<ul style="list-style-type: none"> <li>This message appears if a 3/4"(18-mm)-wide tape cassette is not installed when a template for 3/4"(18-mm)-wide tape is selected.</li> </ul>	<ul style="list-style-type: none"> <li>Install a 3/4"(18-mm)-wide tape cassette.</li> </ul>
SET 1/2" !	<ul style="list-style-type: none"> <li>This message appears if a 1/2"(12-mm)-wide tape cassette is not installed when a template for 1/2"(12-mm)-wide tape is selected.</li> </ul>	<ul style="list-style-type: none"> <li>Install a 1/2"(12-mm)-wide tape cassette.</li> </ul>
SET 3/8" !	<ul style="list-style-type: none"> <li>This message appears if a 3/8"(9-mm)-wide tape cassette is not installed when a template for 3/8"(9-mm)-wide tape is selected.</li> </ul>	<ul style="list-style-type: none"> <li>Install a 3/8"(9-mm)-wide tape cassette.</li> </ul>
SET 1/4" !	<ul style="list-style-type: none"> <li>This message appears if a 1/4"(6-mm)-wide tape cassette is not installed when a template for 1/4"(6-mm)-wide tape is selected.</li> </ul>	<ul style="list-style-type: none"> <li>Install a 1/4"(6-mm)-wide tape cassette.</li> </ul>
SYSTEM ERROR!	<ul style="list-style-type: none"> <li>This message appears if there is a problem with the machine's software.</li> </ul>	<ul style="list-style-type: none"> <li>Contact your service representative.</li> </ul>

ERROR MESSAGE	CAUSE	REMEDY
<p>TOO HIGH!</p> <p>TOO HIGH!</p>	<ul style="list-style-type: none"> <li>• This message appears if the height of the text is larger than the width of the installed tape.</li> <li>• This message appears if you delete a block, causing the size of the text to be taller than the width of the installed tape.</li> </ul>	<ul style="list-style-type: none"> <li>• Reduce the size of the characters or install a tape of greater width.</li> <li>• Hold down  and press  to create a new block or adjust the size of the text so that it will not be taller than the width of the installed tape.</li> </ul>
<p>TOO LONG!</p> <p>TOO LONG!</p>	<ul style="list-style-type: none"> <li>• This message appears if the length of the text is longer than the label length that has been set.</li> <li>• This message appears if the text typed in for an entry using the also formats function exceeds the preset length.</li> </ul>	<ul style="list-style-type: none"> <li>• Delete some of the text, reduce the character width or increase the preset label length.</li> <li>• Enter fewer characters.</li> </ul>
<p>WRONG SELECT</p>	<ul style="list-style-type: none"> <li>• This message appears if more than five characters are selected as the numbering field.</li> <li>• This message appears if characters with different format settings are selected as the numbering field.</li> </ul>	<ul style="list-style-type: none"> <li>• Limit the numbering field to five characters.</li> <li>• Only select characters with identical format settings.</li> </ul>

# TROUBLESHOOTING

PROBLEM	REMEDY
1. The display stays blank after you have turned on the machine or abnormal characters are displayed.	<ul style="list-style-type: none"> <li>• If you are using alkaline batteries, check that they are properly inserted.</li> <li>• If the batteries are low, replace them with new ones.</li> <li>• If the batteries are low, replace them with new ones.</li> <li>• Turn off the machine, then while holding down <span style="border: 1px solid black; padding: 0 2px;">Code</span> and <span style="border: 1px solid black; padding: 0 2px;">R</span>, turn the machine back on to reset it. The text and formats in the display and all text files stored in the memory are erased.</li> </ul>
2. The printed characters are not formed properly.	<ul style="list-style-type: none"> <li>• If you are using alkaline batteries, they may be low. Try using the AC adaptor or replace the batteries with new ones.</li> </ul>
3. The machine does not print or the printed characters are blurred.	<ul style="list-style-type: none"> <li>• Check that the tape cassette has been inserted properly.</li> <li>• If the tape cassette is empty, replace it with a new one.</li> <li>• Make sure that the tape compartment cover has been closed.</li> </ul>
4. A blank horizontal white line appears through the printed label.	<ul style="list-style-type: none"> <li>• Clean the print head as explained on page 19.</li> </ul>
5. Striped tape appears.	<ul style="list-style-type: none"> <li>• You have reached the end of the tape cassette. Replace it with a new one.</li> </ul>
6. The text files that you stored in the memory have been erased.	<ul style="list-style-type: none"> <li>• If the batteries are low, replace them with new ones.</li> </ul>
7. The machine has "locked up" (i.e., nothing happens when a key is pressed).	<ul style="list-style-type: none"> <li>• Turn off the machine, then while holding down <span style="border: 1px solid black; padding: 0 2px;">Code</span> and <span style="border: 1px solid black; padding: 0 2px;">R</span>, turn the machine back on. The text and formats in the display and all text files stored in the memory are erased.</li> </ul>

# MACHINE SPECIFICATIONS

## HARDWARE

Input device:	KEYBOARD – 63 keys
LCD:	112 x 32 dots 23 indicators
Print type:	23 indicators 5 widths available 1/4" (6 mm) 3/8" (9 mm) 1/2" (12 mm) 3/4" (18 mm) 1" (24 mm) 1 1/2" (36 mm)
Power supply	8 AA alkaline batteries (optional AC adapter model AD-60) Auto power off if no key pressed within 5 minutes
Print head:	128 dot / 180 dpi
Dimensions:	8 45/64" x 9 31/32" x 3 27/64" (221 x 253 x 87 mm)
Weight	2 lbs. 10 ozs. (1.2kg)

## SOFTWARE

Character size:	6 sizes (6, 9, 12, 18, 36 and 48 point) + AUTO All are available in NARROW, MEDIUM and MODE
Character fonts:	8 built - in typefaces (P-touch 550) 5 built - in typefaces (P-touch 530)
Buffer size:	Single line - 1 m Multi - line Multi - block
Memory size:	3,400 characters (P-touch 550) 1,000 characters (P-touch 530)
Number of characters:	398 characters
Print styles:	Normal, Bold, Outline, Solid, Shadow, and Outline + Shadow, Striped (each can be combined with Italic)

# FEATURES

The P-touch 530/550 features the following:

- WYSIWYG display
- Color printing
- Stamp creating
- Pre-formatted label templates
- Multi-line printing (up to 7 lines)
- Multi-block printing (up to 5 blocks)
- 7 sizes & 14 styles
- Text and label framing
- Text underling
- Vertical printing
- Mirror printing
- Horizontal alignment adjustment
- Adjustable tape feed
- Label length setting
- Repeat printing
- Split printing
- Numbering function
- Bar code generation
- Zooming in and out



# INDEX

- A**
- A. CUT parameter.....128
- AC adapter.....10,12
- Accent function .....78
- All function.....27,97
- Alt key.....60
- Area key .....39,97
- Auto Formats key.....88
- Automatic backup .....56
- Automatic power off.....56
- B**
- Backspace key.....28,71
- Backup .....56
- Barcode function.....49,80
  - Numbering.....131
  - Parameters .....80
- Batteries .....10,11,56
- Blank display.....146
- Blocks.....47,66
- Bold character style .....104
- C**
- Cancel key.....68
- Caps mode.....24,61
- Cassettes .....10,13-15
- Center alignment.....118
- Character
  - Size .....102
  - Style .....104
  - Width.....102
- CHECK DIG. Parameter.....80
- Cleaning
  - Machine's surface.....10
  - Print head and rollers .....19
- Clear function.....30,77
- CODABAR symbols.....82
- CODE 39 symbols .....82
- Code key .....59
- CODE 128 symbols.....81
- Color key .....109
- COLOR PRINT function .....42,123
- Color printing
  - Frame.....113
  - Ink and tape cassette .....14-15
  - Shading.....113
  - Style .....114
- Colored characters .....114
- Colored frame/shading.....113
- Combination character styles.....104
- Continuing.....63
- Contrast function .....86
- COPIES parameter.....128
- Creating
  - Bar codes.....80
  - Stamps.....125
- Cursor .....23
- Cursor keys.....57
- D**
- Default settings
  - Font.....100
  - Framing.....107
  - Label formats.....110
  - Size .....102
  - Style .....104
  - Text color.....109
  - Text formats.....97-98
  - Underlining.....107
  - Width.....102
- Deleting
  - All characters.....73
  - Characters .....71
  - Stored text files.....135
  - Text lines .....72
- Displaying
  - Final layout .....85
  - Label length .....87
- E**
- EAN 128 symbols.....81
- END key .....58
- Error messages .....139-145
- F**
- Failure to print.....146
- Features.....9
- Feed & Tape Cut key.....117
- FEED (tape feed) function.....117

Font key.....	100
Format key .....	32,40,110
Frame .....	107,112
Color.....	113
FRAME COLOR function.....	41,113
<b>G</b>	
GLOBAL FRAME function.....	33,41,112
<b>H</b>	
H.ALI (horizontal alignment function).....	33,118
HOME key .....	58
<b>I</b>	
Indicator	
Auto Formats .....	88
Caps .....	24,31,61
Color.....	109
Font .....	100
Stamp.....	125
Style .....	104
Zoom .....	85
Indicators.....	23
Ink cassettes .....	13-15
Instant lettering tape .....	17
Iron-on transfers.....	17
Italic character style .....	104
<b>J</b>	
Justifying text .....	118
<b>K</b>	
Keyboard.....	8
<b>L</b>	
Label backing .....	16
Label format functions .....	110-121
Label length	
Displaying.....	87
Selecting .....	116
Label Length function .....	87
Label templates.....	90-96
LCD display .....	8
Left alignment.....	118
LENGTH function.....	116
Line Out function.....	72
Lines.....	31,63
Deleting.....	71

<b>M</b>	
Malformed characters.....	146
Memory	
Deleting.....	135
Recalling .....	135
Storing.....	134
MIRROR (mirror printing) function .....	120
<b>N</b>	
New Block function .....	47,66
Normal character style .....	104
Numbering .....	130
Bar codes.....	131
Symbols .....	130
<b>O</b>	
On/Off key .....	56
Outline character style.....	104
<b>P</b>	
Power key .....	56
Power off.....	56
Precautions.....	10
Print head.....	19
Print key .....	29,122
Printing	
Failure .....	146
Malformed characters .....	146
PROTOCOL parameter.....	80
<b>Q</b>	
Quitting.....	68
<b>R</b>	
Recall function .....	36,135
Removing label backing .....	16
Resetting the machine.....	146
Return key.....	31,63
Right alignment.....	118
Rollers.....	19
Rub-on transfers.....	17
<b>S</b>	
Selecting	
Character size .....	102
Character styles.....	104

Character width.....	102
Fill-in colors.....	114
Fonts.....	100
Frame color.....	113
Frames.....	107,112
Horizontal alignment.....	118
Italics.....	104
Label formats.....	110-121
Label length.....	116
Mirror printing.....	120
Numbering field.....	130
Shading color.....	113
Shading.....	107,112
Tape feed width.....	117
Text colors.....	109
Text formats.....	97-109
Underlines.....	107
Vertical printing.....	119
Seq. Numbering (sequential numbering) function.....	50
Shading.....	107,112
Color.....	113
Shadow character style.....	104,130
Shift key.....	61
Size key.....	102
Solid character style.....	104
Space key.....	25,62
Special Print function.....	35,128
SPLIT parameter.....	128
Stamp function.....	125
Store function.....	28,134
Striped character style.....	104
Striped tape.....	146
STYLE COLOR function.....	41,114
Style key.....	104
Symbol function.....	38,75
Symbols.....	77
Bar codes.....	81-82
Numbering.....	130
<b>T</b>	
Tape cassettes.....	10,13-15
Text	
Deleting.....	71
Recalling.....	135
Storing.....	134
Text format keys.....	27,100-109
Troubleshooting.....	146

Typing	
Accented characters.....	78
Capital letters.....	24,61
<b>U</b>	
UNDER#S parameter.....	80
Underlining.....	107
Color.....	113
Undl/Frm key.....	107
UNIT function.....	121
<b>V</b>	
VERT (vertical printing) function.....	119
<b>W</b>	
Width key.....	102
WIDTH parameter.....	80
WYSIWYG mode.....	23,85
<b>Z</b>	
Zoom key.....	38,85

# ACCESSORIES

- Supplies**

Obtain tape cassettes, AC adapters, and tape cutters from you nearest authorized dealer. Brother cannot be held responsible for trouble caused by the use of unauthorized supplies. Use only Brother TZ tapes with this machine. Do not use tapes that do not have the mark.

Stock No.	Description	QTY/PACKAGE	PRICE
1-1/2" (36 mm) laminated tapes			
TZ-161	Black Characters on Clear Tape	1	\$27.99
TZ-261	Black Characters on White Tape	1	\$27.99
TZ-661	Black Characters on Yellow Tape	1	\$27.99
1" (24 mm) laminated tapes			
TZ-151	Black Characters on Clear Adhesive	1	\$23.99
TZ-251	Black Characters on White Adhesive	1	\$23.99
TZ-451	Black Characters on Red Adhesive	1	\$23.99
TZ-651	Black Characters on Yellow Adhesive	1	\$23.99
TZ-252	Red Characters on White Adhesive	1	\$23.99
TZ-354	Gold Characters on Black Adhesive	1	\$26.99
TZ-355	White Characters on Black Adhesive	1	\$26.99
3/4" (18 mm) laminated tapes			
TZ-141	Black Characters on Clear Adhesive	1	\$20.99
TZ-241	Black Characters on White Adhesive	1	\$20.99
TZ-242	Red Characters on White Adhesive	1	\$20.99
TZ-243	Blue Characters on White Adhesive	1	\$20.99
TZ-344	Gold Characters on Black Adhesive	1	\$24.99
TZ-345	White Characters on Black Adhesive	1	\$23.99
TZ-441	Black Characters on Red Adhesive	1	\$20.99
TZ-541	Black Characters on Blue Adhesive	1	\$20.99
TZ-545	White Characters on Blue Adhesive	1	\$23.99
TZ-641	Black Characters on Yellow Adhesive	1	\$20.99
TZ-741	Black Characters on Green Adhesive	1	\$20.99
TZ-B41	Black Characters on Orange Fluorescent Adhesive	1	\$24.99
TZ-M41	Black Characters on Clear (matte) Adhesive	1	\$23.99
TZ-WB41	Black Characters on Bugs Bunny Adhesive	1	\$23.99
TZ-WT41	Black Characters on Taz Adhesive	1	\$23.99
TZ-WS41	Black Characters on Tweety & Sylvester Adhesive	1	\$23.99
1/2" (12 mm) laminated tapes			
TZ-131	Black Characters on Clear Adhesive	1	\$16.99
TZ-231	Black Characters on White Adhesive	1	\$17.99
TZ-232	Red Characters on White Adhesive	1	\$17.99
TZ-335	White Characters on Black Adhesive	1	\$20.99
3/8" (9 mm) laminated tapes			
TZ-121	Black Characters on Clear Adhesive	1	\$14.99
TZ-221	Black Characters on White Adhesive	1	\$16.99
TZ-325	White Characters on Black Adhesive	1	\$18.99
TZ-421	Black Characters on Red Adhesive	1	\$16.99

Stock No.	Description	QTY/PACKAGE	PRICE
1/4" (6 mm) laminated tapes			
TZ-111	Black Characters on Clear Adhesive	1	\$12.99
TZ-211	Black Characters on White Adhesive	1	\$14.99
TZ-315	White Characters on Black Adhesive	1	\$17.99

Special tapes

Stock No.	Description	QTY/PACKAGE	PRICE
TZ-SE4	Black Characters on 3/4" (18 mm) Security Adhesive	1	\$29.99
TZ-FA3	Blue Characters on 1/2" (12 mm) Fabric Adhesive	1	\$24.99

Multi-color printing cassettes

Stock No.	Description	QTY/PACKAGE	PRICE
TZ-T240	White Tape	1	\$19.99
TZ-R041	Black ink ribbon	1	\$12.99
TZ-R042	Red ink ribbon	1	\$12.99
TZ-R043	Blue ink ribbon	1	\$12.99

Stamp kit

Stock No.	Description	QTY/PACKAGE	PRICE
SK-LB	Stamp Making kit for Large Black	1	\$39.99
SK-MB	Stamp Making kit for Medium Black	1	\$37.99
SH-LB	Additional Stamper for Large Black	1	\$27.99
SH-MB	Additional Stamper for Medium Black	1	\$24.99

Options

Stock No.	Description	QTY/PACKAGE	PRICE
AD-60	AC Adapter for PT-330/350	1	\$24.99









# GUÍA DEL USUARIO

# INTRODUCCIÓN

Enhorabuena por la adquisición de la P-touch 530/550.

Su nueva P-touch le permitirá diseñar y crear etiquetas y membretes para cualquier tipo de aplicación. Su versatilidad le permitirá crear hermosas etiquetas y membretes personales seleccionando distintos diseños de marcos y muchos tamaños y estilos de caracteres. Además, la variedad de cintas y de los colores de las cintas le hará posible imprimir etiquetas personales, útiles para relleno con código de colores.

Ya no hay por qué preocuparse por tareas urgentes que requieren impresión profesional. En la oficina, la fábrica, el laboratorio, o en casa, la calidad y el rendimiento de la P-touch 530/550 la convierten en una máquina muy práctica.

Para terminar, puesto que esa guía del usuario le será de gran utilidad, le aconsejamos que la guarde en un lugar accesible para poderla consultar en cualquier momento.

## AVISO DE FCC

Este equipo ha sido probado y se ha encontrado que satisface los límites para dispositivos digitales de Clase B, según la Parte 15 de las Normas de FCC. Estos límites están preparados para proporcionar una protección razonable contra interferencias dañinas en instalaciones residenciales. Este equipo genera, emplea, y puede radiar energía de radiofrecuencia y, si no se instala de acuerdo con las instrucciones, puede causar interferencias perjudiciales en las radiocomunicaciones. Sin embargo, no se garantiza que ocurrirán interferencias en una instalación en particular. Si este equipo causa interferencias perjudiciales en la recepción de radio o televisión, lo cual puede determinarse conectando y desconectando la alimentación del aparato, se aconseja al usuario que corrija las interferencias mediante una o más de las medidas siguientes:

Reoriente o reubique la antena de recepción.

Aumente la separación entre el equipo y el receptor.

Conecte el equipo a una toma de corriente que esté en un circuito distinto al que se ha conectado el receptor.

Consulte al distribuidor o a un técnico experimentado en radio/TV.

El cable de interfaz incluido deberá utilizarse para asegurar que se satisfacen los límites para aparatos digitales de la Clase B.

Los cambios o modificaciones no expresamente aprobados por BROTHER INDUSTRIES, LTD. pueden invalidar la autoridad del usuario para operar el equipo.

## Este equipo está cubierto por una o más de las patentes siguientes.

USP4839742

USP4983058

EP315369

GB2223740

USP4922063

USP5009530

EP322918

USP4927278

USP5069557

EP322919

USP4966476

USP5120147

USP4976558

# ÍNDICE

PRECAUCIONES GENERALES .....	1
PILAS .....	2
ADAPTADOR DE CA OPCIONAL .....	2
CASSETTES DE CINTA .....	3
CABEZAL DE IMPRESIÓN Y RODILLOS .....	6
TECLAS DEL CURSOR .....	7
TECLAS Code/Alt/Shift Y MODO Caps .....	8
TECLA Cancel .....	10
TECLA BS (RETROCESO) .....	10
FUNCIÓN Line Out .....	11
FUNCIÓN Clear .....	11
FUNCIÓN Symbol .....	12
FUNCIÓN Barcode .....	13
TECLA Zoom .....	16
FUNCIÓN Contrast .....	16
FUNCIÓN Label Length .....	17
TECLA Auto Formats .....	18
TECLA Font .....	20
TECLA Size Y Width .....	21
TECLA Style .....	22
TECLA Undl/Frm (SUBRAYADO/ENCUADRE) .....	24
TECLA Color .....	25
FUNCIÓN DE ENCUADRE COMPLETO .....	26
FUNCIÓN DE COLOR DEL ENCUADRE .....	27
FUNCIÓN DE COLOR DEL ESTILO .....	28
FUNCIÓN DE LONGITUD .....	29
FUNCIÓN DE AVANCE DE LA CINTA (FEED) .....	30
FUNCIÓN DE ALINEACIÓN HORIZONTAL (H.ALI) .....	31
FUNCIÓN DE IMPRESIÓN VERTICAL (VERT) .....	32
FUNCIÓN DE IMPRESIÓN DE ESPEJO (MIRROR) .....	33
FUNCIÓN DE UNIDAD .....	34
FUNCIÓN DE IMPRESIÓN EN COLOR .....	35
FUNCIÓN DE MEMBRETE (Stamp) .....	37
FUNCIÓN DE IMPRESIÓN ESPECIAL (Special Print) .....	39
FUNCIÓN DE NUMERACIÓN SECUENCIAL (Seq. Numbering) .....	41
TECLAS Store, Recall Y M.Del .....	43



# PRECAUCIONES GENERALES

- Con esta máquina emplee sólo cintas TZ Brother. No emplee cintas que no tengan la marca.
- No tire de la cinta que se alimenta desde la P-touch. Podría dañar el cassette de cinta.
- No emplee la máquina en lugares demasiado polvorientos. Manténgala apartada de la luz directa del sol y de la lluvia.
- No exponga la máquina a altas temperaturas ni humedad. No la deje nunca en el tablero de instrumentos ni en la parte trasera de su automóvil.
- No deje nada que sea de goma o vinilo encima de la máquina durante períodos prolongados. Podría producir manchas.
- No limpie la máquina con alcohol ni con otros solventes orgánicos. Emplee solamente un paño suave y seco.
- No ponga ningún objeto encima de la máquina.
- Para evitar daños, no toque el borde de la cuchilla.
- Cuando inserte pilas nuevas, asegúrese de hacerlo antes de que transcurran cinco minutos desde el momento en que extraen las pilas gastadas, porque de lo contrario se perderían todos los archivos de texto (a menos que la máquina esté enchufada a una toma de CA con el adaptador de CA).
- Emplee sólo el adaptador de CA (modelo AD-60) exclusivamente diseñado para esta máquina. El empleo de otro adaptador cancelaría la garantía.
- Cuando la máquina no se utilice durante períodos prolongados de tiempo y no sea necesario conservar los archivos de texto en la memoria, desenchufe el adaptador de CA, y saque las pilas para evitar fugas de las mismas que podrían ser causa de daños en la máquina.
- Si se desenchufa el adaptador de la toma de CA antes de desenchufarlo de la máquina, no se borrarán los archivos de texto de la memoria si las pilas están correctamente instaladas.
- **En esta máquina, emplee pilas alcalinas del tamaño AA.**

## PILAS

Esta máquina ligera y portátil puede utilizarse en cualquier lugar instalando ocho (8) **pilas Alcalinas AA**. Cuando cambie las pilas, reemplace siempre las ocho pilas al mismo tiempo.

-  *Asegúrese de insertar las pilas nuevas antes de que transcurran cinco minutos desde que se extraen las pilas gastadas, porque de lo contrario el texto que se visualiza en la pantalla y los archivos de texto almacenados en la memoria se perderían (a menos que la máquina esté enchufada a una toma de CA con el adaptador de CA).*
- Si no se emplean pilas alcalinas, no podrán imprimirse tipos de caracteres grandes ni Códigos de barras.*

## ADAPTADOR DE LA OPCIONAL



El adaptador de CA (modelo AD-60) le permite emplear esta máquina siempre que disponga de una toma de corriente eléctrica.

-  *Emplee sólo el adaptador de CA diseñado exclusivamente para esta máquina.*
- Si se desenchufa el adaptador de la toma de CA antes de desenchufarlo de la máquina, no se borrarán los archivos de texto de la memoria si las pilas están correctamente instaladas.*
- Se recomienda emplear el adaptador de CA para imprimir tipos de caracteres grandes y códigos de barras con cintas de 18 mm (3/4") o de 24 mm (1") porque grandes operaciones pueden gastar las pilas con rapidez.*



# CASSETTES DE CINTA

Un cassette de TZ se suministra con la unidad. Sin embargo, puesto que para esta máquina hay disponibles una amplia gama de cassettes de cinta TZ, tintas y cassettes de cinta para impresión en color de distintos colores y tamaños, es posible crear etiquetas con distinción codificadas por colores y estilizadas. Además, hemos diseñado esta máquina para permitirle cambiar rápida y fácilmente los cassettes de cinta.

## PARA CAMBIAR UN CASSETTE DE CINTA TZ:

- ➊ Deslice la palanca de liberación de la cubierta hacia la izquierda, y levante la cubierta del compartimiento de la cinta abrirla.
- ➋ Si ya hay un cassette instalado, extráigalo tirando del mismo recto hacia arriba.
- ➌ Si la cinta entintada del cassette está floja, bobine la rueda dentada con el dedo en la dirección de la flecha hasta que la cinta quede tensada. Asegúrese de que el extremo de la cinta se alimenta por debajo de las guías de cinta.  
*✎ Extraiga el tope si el cassette de cinta es nuevo.*
- ➍ Inserte firmemente el cassette de cinta en el compartimiento de la cinta asegurándose de que toda la parte posterior del cassette está en contacto con la inferior del compartimiento.  
*✎ Cuando inserte el cassette de cinta, asegúrese de que la cinta interior no esté enganchada en la esquina de la guía metálica.*
- ➎ Cierre la cubierta del compartimiento, y presione entonces  para conectar la alimentación de la máquina si estaba desconectada.
- ➏ Presione  una vez para tensar la cinta y corte la cinta sobrante.

## PARA CAMBIAR LOS CASSETTES DE TINTA Y DE CINTA PARA IMPRESIÓN EN COLOR:

- 1 Deslice la palanca de liberación de la cubierta hacia la izquierda, y levante la cubierta del compartimiento de la cinta para abrirla.
- 2 Si ya hay un cassette de cinta instalado, extráigalo tirando del mismo recto hacia arriba.
- 3 Inserte el cassette de tinta recto hacia abajo al cassette de cinta.
  - ☞ Si la cinta entintada del cassette está floja, bobine la rueda dentada con el dedo en la dirección de la flecha hasta que la cinta quede tensada.
  - Si el cassette de cinta es nuevo, extraiga la cinta adhesiva del extremo de la cinta y saque unos 12 mm (1/2") de cinta de etiquetas.
  - Si emplea un cassette de cinta usado, asegúrese de que la cinta avence correctamente. (PARA más detalles, consulte la página 5.)
- 4 Inserte firmemente los cassettes de cinta y de tinta en el compartimiento asegurándose de que toda la parte posterior de los cassettes está en contacto con la inferior del compartimiento.
  - ☞ Cuando inserte los cassettes, asegúrese de que la cinta entintada no esté enganchada en la esquina de la guía metálica y que la cinta no esté enhanchada en la cuchilla.
- 5 Cierre la cubierta del compartimiento, y presione entonces  para conectar la alimentación de la máquina si estaba desconectada.
- 6 Presione  una vez para tensar la cinta y corte la cinta sobrante.

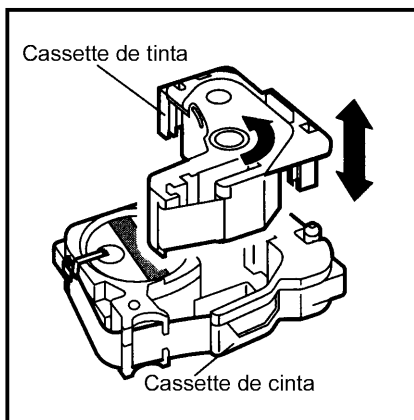



## Avance de la cinta por el cassette

- 1 Extraiga los cassette de cinta y de tinta de la máquina, y luego saque el cassette de tinta del cassette de cinta.
- 2 Guíe la cinta a la caja del cassette.

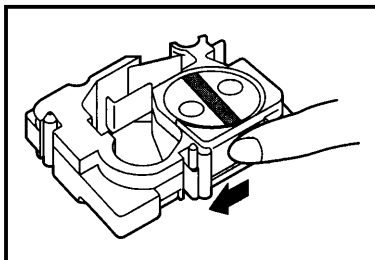

*☞ Si sólo queda un poco de cinta en el cassette, saque un poco más y suminístrela a la ranura.*

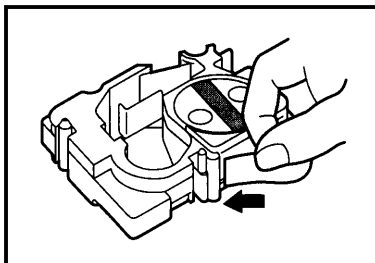

- 3 Guíe el extremo de la cinta por la ranura y entorno a la caja del cassette.

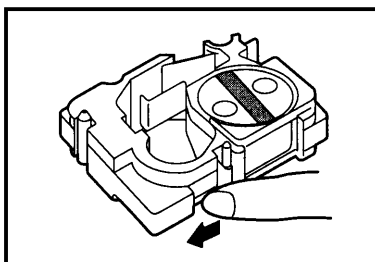

- 4 Deslice la cinta por debajo de las guías de cinta.

*☞ Asegúrese de que la cinta avanza por debajo de las guías de cinta.*

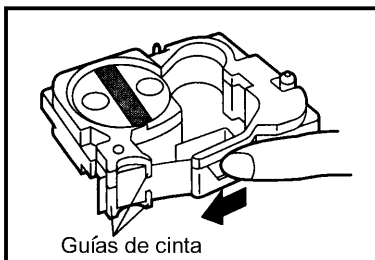

- 5 Tome el extremo de la cinta y gire el rollo de cinta hacia la izquierda para tensar la cinta.

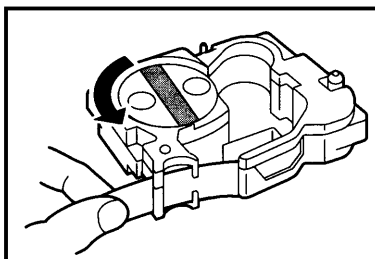

# CABEZAL DE IMPRESIÓN Y RODILLOS

De vez en cuando, motas de polvo o suciedad se adhieren al cabezal de impresión y a los rodillos de la máquina. Suele suceder cuando se emplea la unidad en exteriores o en lugares con mucho polvo. Si alguna parte del cabezal de impresión está cubierta de polvo, es posible que aparezca una franja horizontal blanca por el texto de la etiqueta impresa.

Por lo tanto, al igual que con las grabadoras de cintas, el cabezal de la máquina deberá limpiarse de vez en cuando.

## PARA LIMPIAR EL CABEZAL DE IMPRESIÓN:

- 1 Desconecte la alimentación de la máquina.
- 2 Abra la cubierta del compartimiento de la cinta, y extraiga el cassette de cinta, si está dentro. El cabezal impresión y los rodillos están situados dentro del compartimiento de la cinta.
- 3 Cabezal de impresión: Emplee un palillo con punta de algodón seco para frotar con cuidado el cabezal de impresión con movimiento hacia arriba y abajo.  
Rodillos: Emplee un palillo con punta de algodón seco para frotar cada rodillo con Movimiento hacia arriba abajo mientras los gira con el dedo.
- 4 Pruebe de nuevo la impresión.  
Si todavía queda polvo:
- 5 Repita el paso 3 empleando un palillo con cabeza de algodón humedecido en alcohol isopropílico (limpieza).



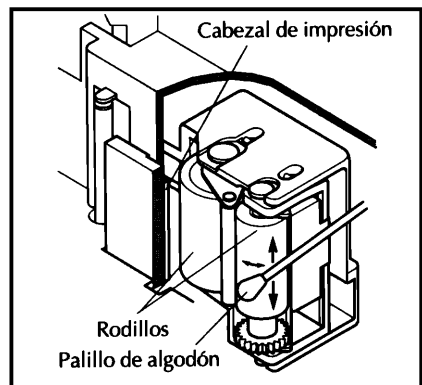
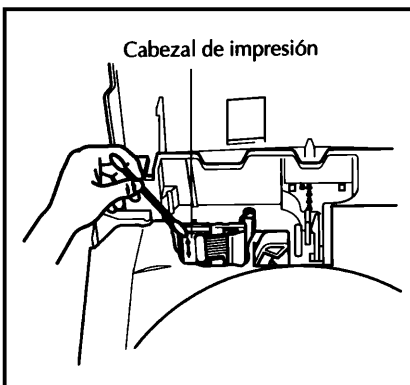

Si no funciona nada de lo de arriba, póngase en contacto con el representante de servicio.







# TECLAS DEL CURSOR

Las cuatro teclas del cursor (  ,  ,  y  ) pueden utilizarse para efectuar dos operaciones distintas: mover el cursor y hacer una selección.



## TECLA DEL CURSOR IZQUIERDA

- Para mover el cursor un carácter hacia la izquierda, presione  una vez. Si el cursor está situado al principio de una línea cuando se presiona esta tecla, el cursor se moverá al final de la línea anterior.
- Para mover el cursor al principio de la línea de texto actual, mantenga presionado  y presione .
- Para mover el cursor al primer carácter del bloque de texto actual, mantenga presionado  y presione . Si el cursor está situado al principio de un bloque de texto, el cursor se moverá al principio del bloque anterior.



## TECLA DEL CURSOR DERECHA

- Para mover el cursor un carácter hacia la derecha, presione  una vez. Si el cursor está situado al final de una línea cuando se presiona esta tecla, el cursor se moverá al principio de la línea siguiente.
- Para mover el cursor al final de la línea de texto actual, mantenga, presionado  y presione .
- Para mover el cursor al principio del siguiente bloque de texto, mantenga presionado  y presione .

## TECLA DEL CURSOR HACIA ABAJO

- Para mover el cursor al carácter de la línea directamente encima de la posición actual del cursor, presione  una vez.
- Para mover el cursor al principio de todo el texto, mantenga presionado  y presione .

## TECLA DEL CURSOR HACIA ABAJO

- Para mover cursor al carácter de la línea directamente debajo de la posición actual del cursor, presione  una vez.
- Para mover el cursor al final de todo el texto, mantenga presionado  y presione .

# TECLAS Code/Alt/Shift Y MODO Caps





La mayor parte de caracteres pueden introducirse presionando sus teclas simplemente. Sin embargo, para emplear funciones especiales o para introducir letras mayúsculas, caracteres acentuados y algunos símbolos, son necesarias las siguientes teclas especiales.

## TECLA Code

- Para emplear una función impresa en color de rosa encima de la tecla, mantenga presionado  y presione la tecla que está inmediatamente debajo de la función deseada.

## TECLA Alt





- Para escribir los caracteres impresos en azul de la tecla, mantenga presionado  y presione la tecla del carácter deseado.

 Para escribir la letra mayúscula de un carácter impreso en azul, mantenga presionado  (o mantenga presionado  y presione  para establecer el modo **Caps** ) antes de presionar la tecla del carácter deseado.

## TECLA Shift

- Para escribir una letra mayúscula o un símbolo impreso en la esquina superior izquierda de la tecla, mantenga presionado  y presione la tecla de la letra o símbolo deseado.

## MODO Caps

- Para establecer el modo **Caps** y escribir una serie de letras mayúsculas, mantenga presionado  y presione . El indicador de **Caps**, de la esquina superior izquierda del visualizador, se encenderá.  
  
*☞ Para escribir letras minúsculas cuando el indicador Caps está encendido, mantenga presionado  mientras presiona la tecla del carácter deseado. Sin embargo, cuando se presionen teclas numéricas, se escribirán los números y no los símbolos que tienen las teclas encima.*  
  
*Los tipos de caracteres que sólo producen letras mayúsculas no pueden utilizarse para introducir letras minúsculas.*
- Para salir del modo **Caps**, mantenga presionado  y presione . Se apagará el indicador de **Caps**.

## TECLA Cancel

La tecla **Cancel** (  ), situada en la fila inferior del teclado, tiene dos funciones básicas.



### ABANDONO DE UNA OPERACIÓN SIN CAMBIAR EL TEXTO

Por lo general, al presionar  se vuelve a la pantalla u operación anterior sin cambiar el texto (por ejemplo, si empieza a emplear una función pero luego decide que no quiere seguir, o cuando se visualiza un mensaje de error).





### RECHAZO DE UNA OPERACIÓN

Algunas veces aparecen preguntas en la pantalla que solicitan la confirmación de una operación, especialmente cuando la función seleccionada sirve para borrar o afectar archivos. En tales casos, presionando  es como si se respondiera "no".

## TECLA BS (RETROCESO)

La tecla retroceso (  ) le permite borrar caracteres hacia la izquierda de la posición actual del cursor. Se diferencia de la tecla del cursor izquierda (  ), que sólo mueve el cursor sin borrar ningún carácter.







### PARA BORRAR UN CARÁCTER

- 1 Presione  ,  ,  o  para situar el cursor en posición inmediatamente a la derecha del carácter que desea borrar.
- 2 Presione  .







## ***FUNCIÓN Line Out***

La función **Line Out** le permite extraer líneas enteras de texto con facilidad.



### **PARA BORRAR UNA LÍNEA DE TEXTO:**

- 1 Presione , ,  o  para situar el cursor en la línea que desee borrar.
- 2 Mantenga presionado  y presione .

## ***FUNCIÓN Clear***

La función **Clear** se emplea para extraer todos los caracteres de la pantalla, y devolver todos los formatos de texto (seleccionados empleando , , ,  y ) y foematos de etiqueta (seleccionados empleando ) a sus ajustes iniciales de fábrica. En otras palabras, la pantalla se vacía por completo. Entonces, puede empezar a introducir nuevo texto y a formatearlo.













### **PARA BORRAR TODO EL TEXTO Y DEVOLVER TODOS LOS FORMATOS DE TEXTO A SUS AJUSTES INICIALES DE FÁBRICA:**

- 1 Mantenga presionado  y presione . Aparecerá el mansage "OK TO CLEAR?" en la panralla.  
*El cursor podrá situarse en cualquier parte del texto.*
- 2 Presione .

# FUNCIÓN Symbol

Además de letras, de los símbolos y los números de la parte superior de las teclas, hay 257 caracteres adicionales disponibles con la función de símbolos. Después de añadir estos caracteres al texto, podrán tratarse como cualquier otro carácter y podrán formatearse o borrarse.

## PARA ESCRIBIR UN SÍMBOLO:

- 1 Mantenga presionado  y presione . Aparecerán algunos símbolos en el visualizador.
  - 2 Presione  o  hasta que el símbolo que desea emplear aparezca en el visualizador.
  - 3 Presione  o  hasta que se ilumine el símbolo deseado.
  - 4 Presione . El símbolo aparecerá en el texto.
-  Si desea escribir una secuencia de símbolos, mantenga presionado  antes de presionar . Siga añadiendo símbolos al texto seleccionándolos, y manteniendo presionado  mientras presiona . Presione solamente  después de haber seleccionado el último símbolo de la secuencia.

Los símbolos no pueden escribirse en un código de barras.



# FUNCIÓN Barcode

La función de códigos barras **Barcode**, que permite añadir códigos de barras a las etiquetas impresas, es una de las características más avanzadas de la máquina.

 En esta sección explicaremos cómo introducir un código de barras en el texto. No tiene el propósito de ser una introducción amplia al concepto de los códigos de barras. Para encontrar información más detallada al respecto, consulte uno de los muchos libros de referencia disponibles en el mercado.

Puesto que esta máquina no está específicamente diseñada para hacer etiquetas de códigos de barras, es posible que algunos lectores de códigos de barras no puedan leer las etiquetas.

Imprima los códigos de barras con tinta negra sobre fondo blanco.



Cuatro parámetros distintos le permiten crear códigos de barras personalizados.



Parámetro	Ajustes
PROTOCOL	CODE 39 1-2/5, EAN13, EAN8, UPC-A, UPC-E, CODABAR, EAN128*, CODE128*, ISBN5*, ISBN2*
	* Sólo disponible en la P-touch 550
WIDTH (anchura del código de barras)	LARGE (grande), SMALL (pequeño)
UNDER#S (números impresos debajo del código de barras)	ON, OFF
CHECK DIG. (dígito de comprobación)	OFF, ON

Los ajustes iniciales son CODE39 PROTOCOL, LARGE WIDTH, UNDER#S ajustado a ON, y CHECK DIG ajustado a OFF.

 Recomendamos imprimir los códigos de barras empleando la función FEED ajustada a FULL y el parámetro WIDTH de códigos de barras ajustado a LARGE (grande). De lo contrario, es posible que los códigos de barras sean difíciles de leer.



## PARA CERAR UN CÓDIGO DE BARRAS:



1 Mantenga presionado  y presione .



 Para cambiar los datos o parámetros de un código de barras que ya ha sido creado, sitúe el cursor a mitad del código de barras antes mantenga presionado  y de presionar , y entonces cambie los datos se visualizan o los parámetros del código de barras.



## Selección de los ajustes de parámetros de código de barras

2 Presione .

 Para seguir creando un código de barras sin cambiar los ajustes de los parámetros, presione .

3 Presione  o  hasta que se ilumine el ajuste del parámetro que usted desee cambiar.

4 Presione  o  hasta que se visualice el ajuste deseado.

 Para seleccionar el ajuste inicial de fábrica, presione .



5 Repita los pasos 3 y 4 hasta ajustar todos los parámetros como usted desee.



6 Presione .



## Introducción de los datos del código barras

7 Escriba los datos del nuevo código de barras o edite los datos existentes.

## Adición de un carácter especial a los datos del código de barras

8 Presione  o  hasta que el cursor esté debajo del carácter que se encuentra inmediatamente a la derecha de posición en la que usted desea añadir el carácter especial.

9 Mantenga presionado  y presione .

10 Presione  o  hasta que se visualice el carácter especial deseado.

Los caracteres especiales siguientes sólo pueden introducirse cuando se emplea los tipos EAN 128 o Code 128.

VALOR	CARÁCTER	VALOR	CARÁCTER	VALOR	CARÁCTER
3	#	71	DEL	89	EM
4	\$	72	BS	90	SUB
11	+	73	HT	91	ESC
28	<	74	LF	91	{
29	=	75	VT	92	FS
30	>	76	FF	92	
32	@	77	CR	93	GS
59	[	78	SO	93	}
60	\	79	SI	94	RS
61	]	80	DLE	94	~

VALOR	CARÁCTER	VALOR	CARÁCTER	VALOR	CARÁCTER
63	—	81	DC1	95	US
63	NUL	82	DC2	95	DEL
65	SOH	83	DC3	96	FNC3
66	STX	84	DC4	97	FNC2
67	ETX	85	NAK	100	FNC4
68	EOT	86	SYN	102	FNC1
69	ENQ	87	ETB		
70	ACK	88	CAN		

Los símbolos siguientes sólo pueden introducirse cuando se emplea los protocolos CODE 39 o CODABAR.

SYMBOL	CARÁCTER
1	+
2	\$

- 11 Presione  para añadir el carácter especial seleccionado a los datos del código de barras.





#### Adición del código de barras al texto

- 12 Presione  .

## TECLA Zoom

Normalmente, el texto se introduce y visualiza en el modo WYSIWYG (se obtiene tal y como se ve), que le muestra exactamente como aparecería la etiqueta si se imprimiera. Sin embargo, con la tecla **Zoom** usted podrá acercarlo para ver el texto en detalle, o podrá alejarlo para ver como quedaría el texto en la etiqueta impresa.









### PARA EMPLEAR LA FUNCIÓN DEL ZOOM:

- 1 Presione  una vez para acercar texto. Se encenderá el indicador de **Zoom** de la parte inferior del visualizador.  
*☛ Para devolver el visualizador al WYSIWYG, presione  en cualquier momento.*
- 2 Presione  otra vez para visualizar cómo quedará el texto en la etiqueta impresa. El indicador de **Zoom** quedará encendido.
- 3 Presione  otra vez para devolver el visualizador al modo WYSIWYG. Se apagará el indicador de **Zoom**.

## FUNCIÓN Contrast

Esta función se emplea que la visualización sea más clara o más oscura. La función **Contrast** puede utilizarse desde el modo de visualización WYSIWYG o mientras se emplean las funciones de formatos automáticos o de membrete (**Stamp**).

### PARA CAMBIAR EL CONTRASTE:

- 1 Mantenga presionado  y presione .
- 2 Presione  o  para ajustar el contraste.  
*☛ Para reponer el contraste al ajuste inicial de fábrica, presione  (o mantenga presionado  y presione ).*
- 3 Presione .

## ***FUNCIÓN Label Lenght***

Esta función se emplea para visualizar la longitud de la etiqueta en pulgadas o en centímetros, dependiendo del ajuste de la función UNIT. Para más información sobre el cambio de unidades que se emplean para visualizar la longitud, consulte a FUNCIÓN UNIDAD de la página.

- Para visualizar la longitud de la etiqueta, mantenga presionado  y presione .

 Presione  para devolver el visualizador al modo WYSIWYG.

# TECLA Auto Formats



La tecla Auto Formats (  ) está situada en la espuina inferior izquierda del teclado. Después de presionar esta tecla, seleccione simplemente una plantilla preajustada e introduzca el texto en cada una de las entradas de la plantilla para varias aplicaciones, tales como para direcciones de sobres de correo y para identificar discos flexibles o cassettes de audio o de vídeo. Esta función hace que la creación de etiquetas sea más rápida y más fácil que si tuviera que formatear el texto usted mismo.

## PARA EMPLEAR LA FUNCIÓN DE FORMATOS AUTOMÁTICOS:

1 Presione  . Se encenderá el indicador **Auto Formats**.



*Si el texto ya ha sido introducido, aparecerá el mensaje "OK TO CLEAR TEXT BUFFER?"*

*en el visualizador. Presione  para borrar el texto.*

*Si el indicador **Auto Formats** ya estaba encendido cuando se presionó  podrá elegir entre el ajuste **NEW TXT** para crear un texto nuevo, o el ajuste **EDIT TEXT** para editar el texto actualmente visualizado. presione  o  para seleccionar el ajuste*



*deseado, y luego presione .*

## Seleccione una plantilla para crear un texto nuevo

2 Presione  o  hasta que se visualice la plantilla que usted desee utilizar.

3 Presione .

## Introducción o edición de texto de la plantilla

4 Para cada entrada, escriba el texto y presione luego . Cuando se presione  después de haber introducido el texto para la última entrada, aparecerá el mensaje "OK TO FINISH INPUTTING DATA".

5 Presione  para devolver el visualizador al modo WYSIWYG.

**Plantilla de etiquetas preajustadas**

VCR VHS (3/4" (18 mm))
VCR 8mm-1 (3/8" (9 mm))
VCR 8mm-2 (1/2" (12 mm))
VCR VHSC-1 (1/2" (12 mm))
VCR VHSC-2 (3/4" (18 mm))
AUDIO-1 (1/4" (6 mm))
AUDIO-2 (3/8" (9 mm), 1/2" (12 mm))
AUDIO-3 (3/8" (9 mm), 1/2" (12 mm))
NAME PLATE (3/4" (18 mm), 1 1/2" (36 mm))
ADDRESS (3/4" (18 mm), 1 1/2" (36 mm))
EQUIPMENT (3/4" (18 mm), 1" (24 mm), 1 1/2" (36 mm))
EQUIPMENT (1/2" (12 mm))
SLIDE (1/2" (12 mm))
PRICE (3/4" (18 mm), 1" (24 mm), 1 1/2" (36 mm))
SALE PRICE (3/4" (18 mm), 1" (24 mm), 1 1/2" (36 mm))
FILE LONG (3/4" (18 mm), 1" (24 mm), 1 1/2" (36 mm))
FILE LONGV (3/4" (18 mm), 1" (24 mm), 1 1/2" (36 mm))
FILE SHORT (3/8" (9 mm), 1/2" (12 mm), 3/4" (18 mm), 1" (24 mm), 1 1/2" (36 mm))
FLOPPY 3.5 $\varnothing$ (3/4" (18 mm), 1" (24 mm), 1 1/2" (36 mm))
FLOPPY 5 $\varnothing$ (3/4" (18 mm), 1" (24 mm), 1 1/2" (36 mm))

# TECLA Font

Con la tecla **Font** () , podrá cambiar el tipo de caracteres seleccionándolo en una amplia variedad de tipos de caracteres para su texto.

Los ajustes de tipos de caracteres siguientes están disponibles en la P-touch 530:





Tipo 1 (Helsinki), Tipo 2 (Brussels), Tipo 3 (Calgary), Tipo 4 (US), Tipo 5 (Belgium)

Los ajustes de tipos de caracteres siguientes están disponibles en la P-touch 550:









Tipo 1 (Helsinki), Tipo 2 (Brussels), Tipo 3 (Calgary), Tipo 4 (US), Tipo 5 (San Diego), Tipo 6 (Florida), Tipo 7 (Istanbul), y Tipo 8 (Bermuda)

El ajuste del tipo de caracteres seleccionado para la posición actual del cursor se muestra en los indicadores **Font** encima del visualizador. El ajuste inicial del tipo de caracteres es el Tipo 1 (Helsinki). Consulte el apartado de MUESTRAS, al final de esta sección, para ver muestras de los ajustes disponibles.

## PARA SELECCIONAR UN TIPO DE CARACTERES ANTES DE INTRODUCIR EL TEXTO:



- 1 Presione  ,  ,  o  para mover el cursor a la posición en la que desee empezar a utilizar un ajuste de un juego caracteres distinto.
- 2 Presione  hasta que el carácter de muestra (A) se visualice con el ajuste del tipo de caracteres que desee utilizar. El tipo de caracteres actualmente seleccionado se muestra con el indicador Font de encima del visualizador.
- 3 Introduzca el texto.

## PARA CAMBIAR EL TIPO DE CARACTERES DE UN ÁREA SELECCIONADA:

- 1 Seleccione el texto manteniendo presionado  y presionado  para seleccionar todo, el texto, o presionando  y empleando  ,  ,  o  para seleccionar sólo parte del mismo.
- 2 Presione  hasta que se visualice el texto con el ajust del tipo de caracteres que desee utilizar. El tipo de caracteres actualmente seleccionado se muestra con el indicador Font encima del visualizador.
- 3 Presione  . El texto seleccionado se visualiza con el tipo de caracteres seleccionado.



# TECLA Size Y Width

El tamaño de los caracteres puede ajustarse empleando las teclas **Size** () de tamaño y **Width** () de anchura. Con el ajuste de tamaño AUTO, la máquina compara su texto con la anchura de la cinta instalada y ajusta automáticamente los caracteres al tamaño más grande posible. Sin embargo, hay también otros siete tamaños de puntos desponibles y cada uno puede imprimirse con caracteres estrechos, medios, o anchos.







El ajuste del tamaño de ajuste inicial es AUTO y el ajuste inicial para la anchura es media. Cuando se selecciona el ajuste del tamaño AUTO, "AUTO" aparece en la esquina superior izquierda del visualizador. Consulte el apartado de MUESTRAS, al final de esta sección, para ver muestras de los ajustes disponibles.

 Cuando el parámetro **SPLIT** de la función **Special Print** se ajusta a ON, el texto se imprimirá automáticamente en un tamaño de caracteres grandes. Consulte la **FUNCIÓN DE IMPRESIÓN ESPECIAL (Special Print)** de las páginas 39 a 40 para encontrar más detalles.











*Puesto que el tamaño de caracteres que puede utilizarse depende de la anchura de la cinta, la tabla indica los tamaño de caracteres que pueden utilizarse con cada anchura de cinta.*

Anchuras de cinta	Tamaños (en puntos)
1 1/2" (36 mm)	6,9,12,18,24,36,48
1" (24 mm)	6,9,12,18,24,36,48
3/4" (18 mm)	6,9,12,18,24,36
1/2" (12 mm)	6,9,12,18,24
3/8" ( 9 mm)	6,9,12,18
1/4" ( 6 mm)	6,9,12

## PARA SELECCIONAR UN TAMAÑO Y UNA ANCHURA ANTES DE INTRODUCIR EL TEXTO:





















- 1 Presione , ,  o  para mover el cursor a la posición en que desee empezar a utilizar un ajuste de un tamaño o anchura de caracteres distinto.
- 2 Presione  hasta que el carácter de muestra (A) se visualice con el ajuste del tamaño de caracteres que desee utilizar y presione  hasta que se visualice el carácter de muestra con el ajuste deseado.
- 3 Introduzca el texto.

## PARA CAMBIAR EL TAMAÑO Y ANCHURA DE CARACTERES DE UN ÁREA SELECCIONADA:

- 1 Seleccione el texto manteniendo presionado  y presionando  para seleccionar todo el texto, o presionando  y empleando , ,  o  para seleccionar sólo parte del mismo.
- 2 Presione  hasta que se visualice el texto con el ajuste del tamaño de caracteres que desee utilizar, y presione  hasta que se visualice el texto con el ajuste de la anchura deseado.
- 3 Presione . El texto seleccionado se visualiza con el tamaño y anchura de caracteres seleccionados.

## TECLA Style





Podrá seleccionar uno de 14 estilos de distintos para crear etiquetas más decorativas. Hay disponibles los siguientes ajustes de estilos:

 (Normal)	 (Cursiva)
 (Negrilla)	 &  (Cursiva y Negrilla)
 (Perfilado)	 &  (Cursiva y Perfilado)
 (Sólido)	 &  (Cursiva y Sólido)
 (Sombreado)	 &  (Cursiva y Sombreado)
 (Perfilado y Sombreado)	 &  (Cursiva y Perfilado + Sombreado)
 (Franjas)	 &  (Cursiva y Franjas)









El ajuste de estilo seleccionado para la posición actual del cursor se muestra con los indicadores de estilo debajo del visualizador. El ajuste inicial de fábrica es (normal). Consulte el apartado de MUESTRAS, al final de esta sección, para ver muestras de los ajustes disponibles.

 *Los caracteres que se imprimen utilizando ajustes de tamaños más pequeños pueden resultar difíciles de leer si se seleccionan ciertos ajustes de estilos (por ejemplo, cursiva y sombreado).*

## PARA SELECCIONAR UN ESTILO ANTES DE INTRODUCIR EL TEXTO:

- 1 Presione , ,  o  para mover el cursor a la posición en la que desee empezar a utilizar un ajuste de un estilo distinto.
- 2 Presione  hasta que el carácter de muestra (A) se visualice con el ajuste del estilo que desee utilizar. El estilo actualmente seleccionado se muestra con los indicadores de estilo debajo del visualizador.
- 3 Introduzca el texto.

## PARA CAMBIAR EL ESTILO DE ÁREA SELECCIONADA:

- 1 Seleccione el texto manteniendo presionado  y presionando  para seleccionar todo el texto, o presionando  y empleando , ,  o  para seleccionar sólo parte del mismo.
- 2 Presione  hasta que se visualice el texto con el estilo que desee utilizar. El estilo actualmente seleccionado se muestra con los indicadores de estilo debajo del visualizador.
- 3 Presione . El texto seleccionado se visualiza el estilo seleccionado.

## TECLA Undl/Frm (SUBRAYADO/ENCUADRE)

Con la tecla **Undl/Frm** () , podrá seleccionar una amplia variedad de funciones para acentuar y hacer desracar parte de su texto. El ajuste inicial de fábrica es el de texto normal sin ninguno de los siguientes ajuste de subrayado/encuadre.

Recuadro



Puntos



Reticulado



Recuadro redondeado



Bloques



Enrejado diamante



Subrayado



Rejilla cuadrada



Franjas



Tachado







Recuadros pequeños











Cubos



### PARA SELECCIONAR UN AJUSTE DE SUBRAYADO/ENCUADRE ANTES DE INTRODUCIR EL TEXTO:

- 1 Presione  ,  ,  o  para mover el cursor a la posición en la que desee empezar a utilizar un ajuste distinto de subrayado/encuadre.
- 2 Presione  hasta que el carácter de muestra (A) se visualice con el ajuste de subrayado/encuadre que desee utilizar.
- 3 Introduzca el texto.

### PARA CAMBIAR EL AJUSTE DE SUBRAYADO/ENCUADRE DE UN ÁREA SELECCIONADA:





- 1 Seleccione el texto manteniendo  y presionando  para seleccionar todo el texto, o presionando  y empleando  ,  ,  o  para seleccionar sólo parte del mismo.
- 2 Presione  hasta que se visualice el texto con el ajuste de subrayado/encuadre que desee utilizar.
- 3 Presione  . El texto seleccionado se visualiza con el ajuste de subrayado/encuadre seleccionado.

# TECLA Color









Con la tecla **Color** () , podrá seleccionar distintas partes del texto para que se impriman en colores de tinta distintos y crear así etiquetas con colorido.

El ajuste del color seleccionado para la posición actual del cursor se muestra con los indicadores de **Color** encima del visualizador. El ajuste inicial de fábrica es COLOR1. Para más detalles sobre la impresión en color, consulte la FUNCIÓN DE IMPRESIÓN EN COLOR en las paginas 35 a 36.

## PARA SELECCIONAR UN AJUSTE DE COLOR ANTES DE INTRODUCIR EL TEXTO:

- 1 Presione  ,  ,  o  para mover el cursor a la posición en la desee empezar a utilizar un ajuste de un color distinto.
- 2 Presione  hasta que el carácter de muestra (A) se visualice con el ajuste del color que desee utilizar. El color actualmente seleccionado se muestra con los indicadores de **Color** encima del visualizador.
- 3 Introduzca el texto.

## PARA CAMBIAR EL AJUSTE DEL COLOR DE UN ÁREA SELECCIONADA:

- 1 Seleccione el texto manteniendo presionado  y presionando  para seleccionar todo el texto, o presionando  y empleando  ,  ,  o  para seleccionar sólo parte del mismo.
- 2 Presione  hasta que se visualice el ajuste del color que desee utilizar. El ajuste de color actualmente seleccionado se muestra con los indicadores de **Color** encima del visualizador.
- 3 Presione  . El texto seleccionado se visualiza con el ajuste del color seleccionado.

# FUNCIÓN DE ENCUADRE COMPLETO

Podrá crear etiquetas exclusivas encuadrando todo el texto para hacerlo destacar con uno de los numerosos encuadres y sombreados disponibles. El ajuste inicial de fábrica es OFF (sin encuadre no sombreado); sin embargo, los ajustes siguientes están también disponibles.

Recuadro

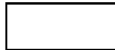

Recuadro redondeado

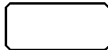

Puntos

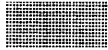

Bloques



Rejilla cuadrada



Recuadros pequeños



Reticulado



Enrejado diamante

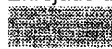

Franjas

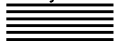

Cubos



Rebajas

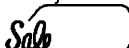

Dedo señalador

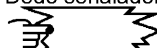

Signos de madera

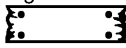

Perro

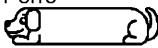

Película

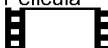

Dinosaurio

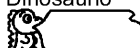

Teléfono

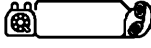

Manos

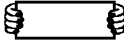

Ventenilla

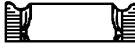

Pendón

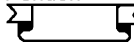

La función de ENCUADRE COMPLETO sólo puede aplicarse a todo el texto; no puede aplicarse a sólo una parte del texto. Sin embargo, los patrones de recuadro, recuadro redondeado y sombreado pueden aplicarse a sólo parte del texto según se explica en TECLA Undl/Frm (SUBRAYADE/ENCUADRE) de la página 24.

## PARA CAMBIAR EL ENCUADRE O SOMBRADO PARA TODO EL TEXTO:

- 1 Presione .
- 2 Presione o hasta que se ilumine el ajuste para la función de ENCUADRE COMPLETO.
- 3 Presione o hasta que se visualice el encuadre que desee emplear.
- 4 Presione . Se visualizará el texto con el encuadre seleccionado.

# FUNCIÓN DE COLOR DEL ENCUADRE







Podrá seleccionar cuál de los tres colores de tinta se deberá emplear para imprimir cualquier subrayado, encuadre, tachado, o sombreado del texto durante la impresión en color. Para más detalles sobre la impresión en color, consulte la FUNCIÓN DE IMPRESIÓN EN COLOR en las páginas 35 a 36.

El ajuste inicial de fábrica es COLOR 1.

 Antes de imprimir con la función de IMPRESIÓN EN COLOR, asegúrese de haber ajustado la función de COLOR DEL ENCUADRE.

*En color seleccionado con la función de COLOR DEL ENCUADRE se aplicará a todos los subrayados, encuadres, tachados o sombreados del texto; no puede aplicarse sólo a una parte del texto. Si no añadido un subrayado, encuadre, tachado o sombreado al texto, el ajuste seleccionado para esta función se ignorará durante la impresión en color.*

## PARA CAMBIAR EL COLOR DEL SUBRAYADO, ENCUADRE, TACHADO Y SOMBRADO:

- 1 Presione .
- 2 Presione  o  hasta que se ilumine el ajuste para función de COLOR DEL ENCUADRE.
- 3 Presione  o  hasta que se visualice el ajuste de color que desee emplear.
- 4 Presione . El ajuste de color seleccionado se aplicará a todos los subrayados, encuadres, tachados y sombreados.







# **FUNCIÓN DE COLOR DEL ESTILO**

Cuando emplee la función de IMPRESIÓN EN COLOR para imprimir texto formateado en cualquier estilo que no sea A (normal) o A (negrilla), podrá seleccionar un color de relleno para las partes de caracteres que normalmente se dejan en blanco como se muestra en el apartado de MUESTRAS. Para más detalles sobre la impresión en color, consulte la FUNCIÓN DE IMPRESIÓN EN COLOR en las páginas 35 a 36.

El ajuste inicial de fábrica es OFF.

 *Antes de imprimir con la función de IMPRESIÓN EN COLOR, asegúrese de haber ajustado la función de COLOR DEL ESTILO.  
La función de COLOR DEL ESTILO sólo puede aplicarse a todo de texto; no puede aplicarse sólo a una parte del texto. Si sólo se utilizan los ajustes de A (normal) y A (negrilla) en le texto, el ajuste seleccionado para esta función se ignorará durante la impresión en color.*

## **PARA CAMBIAR EL COLOR DE RELLENO DE CARACTERES:**

- 1 Presione .
- 2 Presione  o  hasta que se ilumine el ajuste para la función de COLOR DEL ESTILO.
- 3 Presione  o  hasta que se visualice el ajuste que desee emplear.
- 4 Presione . Las partes de los caracteres que normalmente dejan en blanco recibirán el ajuste del color seleccionado.



# FUNCIÓN DE LONGITUD







La longitud de la etiqueta puede ajustarse de dos formas distintas. Con el ajuste de longitud AUTO, la máquina compara el texto introducido con el tamaño de la cinta instalada y ajusta automáticamente la longitud de la etiqueta para adaptarla al texto. Sin embargo, si usted desea ajustar la longitud de la etiqueta, podrá ajustarla entre 3,8 cm (1,5") y 28,7 cm (11,3").

El ajuste inicial de fábrica es AUTO.

 La función de LONGITUD sólo puede aplicarse a todo el texto; no puede aplicarse sólo a una parte del texto.

Si el texto no se acopla dentro de la longitud ajustada, aparecerá el mensaje de error "TOO LONG".

## PARA CAMBIAR LA LONGITUD DE LA ETIQUETA:

- 1 Presione  .
- 2 Presione  o  hasta que se ilumine el ajuste para la función de LONGITUD.
- 3 Presione  o  hasta que se visualice el ajuste que desee emplear. Si se presiona una de las teclas una vez, la longitud cambiará en 0,1 cm (0,1" se se visualizan pulgadas). Se se mantiene presionada la tecla, la longitud seguirá cambiando en pasos de 1,0 cm (1") hasta que se suelta la tecla.
- 4 Presione  . Se aplicará a la etiqueta el ajuste de la longitud seleccionada.

# FUNCIÓN DE AVANCE DE LA CINTA (FEED)

La función de AVANCE DE LA CINTA le permite seleccionar el tamaño de los márgenes izquierdo y derecho de su texto.

El ajuste inicial de fábrica es FULL; aunque también tendrá disponibles otros ajustes.

FULL (25 mm (1"))

NONE (4 mm (1/6"))

NARROW (8 mm (1/3"))







MEDIUM (12 mm (1/2"))

 La función de AVANCE DE LA CINTA sólo puede aplicarse a todo el texto; no puede aplicarse sólo a parte del texto.

*Puesto que la reducción del avance de la cinta puede reducir la legibilidad de los códigos de barras, se recomienda el ajuste FULL de avance de a cinta cuando el texto contenga códigos de barras.*

*Si hay instalado un cassette de cinta de letras instantáneas (transferencia por frotación) o de transferencia por calor, el texto se imprimirá con el ajuste FULL (márgenes de 25 mm (1")), aunque se haya seleccionado un ajuste distinto.*

## PARA CAMBIAR LA ANCHURA DE AVANCE DE LA CINTA:

- 1 Presione  .
- 2 Presione  o  hasta que se ilumine el ajuste para la función de AVANCE DE LA CINTA.
- 3 Presione  o  hasta que se visualice la anchura de avance de la cinta que desee emplear.
- 4 Presione  . El texto se visualizara con la anchura de avance de la cinta seleccionada.

# FUNCIÓN DE ALINEACIÓN HORIZONTAL (H.ALI)

Podrá seleccionar la a alineación del texto de cuatro formas.







El ajuste inicial de fábrica es LEFT; aunque tendrá también disponibles otros ajustes.

LEFT  
CENTER  
RIGHT  
JUSTIFY

 La función H.ALI. (alineación horizontal) sólo puede aplicarse a todo el texto; no puede aplicarse sólo a parte del texto.

*Si la longitud de la etiqueta para un texto que contiene bloques múltiples se ha ajustado con la función LENGTH y su alineación horizontal se ha ajustado a JUSTIFY, los espacios entre los bloques se ajustan de modo que el texto queda uniforme en toda la etiqueta.*

## PARA CAMBIAR LA ALINEACIÓN HORIZONTAL DEL TESTO:

- 1 Presione  .
  - 2 Presione  o  hasta que se ilumine el ajuste para la función de H.ALI.
  - 3 Presione  o  hasta que se visualice el ajuste de la alineación que desee emplear.
  - 4 Presione  . Se visualizará el texto con la alineación seleccionada.
-

# **FUNCIÓN DE IMPRESIÓN VERTICAL (VERT)**







El texto introducido podrá imprimirse verticalmente a lo largo de la etiqueta.

El ajuste inicial de fábrica es OFF.

 *La función VERT (impresión vertical) sólo puede aplicarse a todo de texto; no puede aplicarse sólo a parte del texto.*

*Cualquier etiqueta que usted cree podrá imprimirse empleando esta función.*

## **PARA CAMBIAR EL AJUSTE DE IMPRESIÓN VERTICAL:**

- 1 Presione .
- 2 Presione  o  hasta que se ilumine el ajuste para la función de VERT.
- 3 Presione  o  hasta que se visualice el ajuste de impresión vertical que desee emplear.
- 4 Presione . Se visualizará el texto con el ajuste de impresión vertical seleccionado.

# **FUNCIÓN DE IMPRESIÓN DE ESPEJO (MIRROR)**

Con esta función, podrá imprimir el texto de modo que los caracteres puedan leerse desde el lado del adhesivo de la cinta. Si se adhieren etiquetas con impresión de espejo, usando cinta transparente, a un vidrio, como pueda ser en un escaparate, o en otro material transparente, podrán leerse correctamente desde el lado opuesto.







El ajuste inicial de fábrica es OFF.

 Cuando la función MIRROR se ajusta a ON, imprima el texto transparente.

*La función de impresión de espejo (MIRROR) sólo puede aplicarse a todo el texto; no puede aplicarse sólo a parte del texto.*

*Cualquier etiqueta creada puede imprimirse empleando esta función.*

## **PARA CAMBIAR EL AJUSTE DE LA IMPRESIÓN DE ESPEJO:**







- 1 Presione  .
- 2 Presione  o  hasta que se ilumine el ajuste para la función de MIRROR.
- 3 Presione  o  hasta que se visualice el ajuste de la impresión de espejo que desee emplear.
- 4 Presione  .

# FUNCIÓN DE UNIDAD

Las mediciones se muestran en el visualizador en centímetros (cm) o en pulgadas (inch). Con esta función, usted podrá seleccionar las unidades utilizadas para visualizar las mediciones. El ajuste inicial de fábrica es el de pulgadas (inch).

 Esta ajuste sólo puede aplicarse a todas las mediciones; no puede aplicarse sólo a parte de ellas.

## PARA CAMBIAR LA UNIDAD DE LAS MEDICIONES:



- 1 Presione .
- 2 Presione  o  hasta que se ilumine el ajuste para la función de UNIDAD.
- 3 Presione  o  hasta que se visualice el ajuste de la unidad que desee emplear.
- 4 Presione . Todas las mediciones se visualizarán en unidades seleccionadas.

# FUNCIÓN DE IMPRESIÓN EN COLOR

Con la función de IMPRESIÓN EN COLOR, podrá crear etiquetas de color empleando colores hasta de tres tintas. Esta función es útil cuando parte del texto debe destacar más o cuando se requieren etiquetas con un color diferente.

## PARA IMPRIMIR UNA ETIQUETA CON LA FUNCIÓN DE IMPRESIÓN EN COLOR:

1 Decida el color de la tinta que desee emplear como COLOR1, COLOR2, y COLOR3.

☛ Antes de imprimir con la función de IMPRESIÓN EN COLOR, emplee  para seleccionar el ajuste del color para cada parte de la etiqueta y presione  para ajustar las funciones del COLOR DEL ENCUADRE y del COLOR DEL ETILO. (Para más detalles, consulte las paginas 27 a 28.)



2 Inserte el cassette de tinta para el primer color (el color que se empleará para imprimir las partes del texto ajustadas al COLOR1) en un cassette de cinta de impresión en color, e insértelos luego en el compartimiento de la cinta.

☛ Asegúrese de que toda la parte posterior de los cassette está en contacto con la inferior del compartimiento.

3 Presione . Aparecerá el ajuste para la función de IMPRESIÓN EN COLOR.

☛ Este ajuste aparecerá sólo si se han seleccionado por lo menos dos ajustes de color y se se han instalado los cassette de tinta y de cinta de impresión en color.



Los ajustes de parámetros seleccionados para la función **Special Print** se ignoran durante la impresión en color.

4 Presione  o  hasta que aparezca el ajuste ON, y presione entonces . Se visualizará el mensaje "INSERT COLOR1".

☛ Antes de imprimir, asegurese de que haya cinta suficiente en el cassette de cinta, porque de lo contrario la etiqueta no imprimirá correctamente.

Para abandonar la función de IMPRESIÓN EN COLOR en cualquier momento, presione .

Si no se ha ajustado algún ajuste de color (COLOR1, COLOR2, o COLOR3), los mensajes de esta ajuste de color se saltaran y se visualizará el mensaje para el siguiente color.

- 5 Abra la cubierta del compartimiento y compruebe que el cassette de la primera tinta esté instalado, y cierre entonces la cubierta, y presione . Entonces aparecerá el mensaje "WORKING" en el visualizador justo antes de iniciarse la impresión, y luego aparecerá "COPIES COLOR1" en el visualizador mientras se imprime el texto asignado a COLOR1. Cuando termine la impresión, aparecerá "REWIND TAPE & INSERT COLOR2" en el visualizador.
- 6 Abra la cubierta del compartimiento y rebobine el rollo de la cinta con el dedo para girarla hacia la izquierda hasta que le extremo de la cinta se alinee con la ranura de salida de la cinta.
- 7 Extraiga el primer cassette de tinta e inserte el segundo cassette de tinta, cierre entonces la cubierta, y presione . Entonces aparecerá el mensaje "WORKING" en el visualizador, y luego aparecerá "COPIES COLOR2" en el visualizador mientras se imprime el texto asignado a COLOR2. Cuando termine la impresión, aparecerá "REWIND TAPE & INSERT COLOR3" en el visualizador.
- 8 Abra la cubierta del compartimiento y rebobine el rollo de la cinta con el dedo para girarla hacia la izquierda hasta que le extremo de la cinta se alinee con la ranura de salida de la cinta.
- 9 Extraiga el primer cassette de tinta e inserte el segundo cassette de tinta, cierre entonces la cubierta, y presione . Entonces aparecerá el mensaje "WORKING" en el visualizador, y luego aparecerá "COPIES COLOR3" en el visualizador mientras se imprime el texto asignado a COLOR3.
- 10 Después de que la etiqueta se corta automáticamente, emplee entonces unas tijeras para cortar a lo largo de los puntos impresos de la etiqueta para hacer márgenes iguales.



# FUNCIÓN DE MEMBRETE (STAMP)





La función de membrete **Stamp** le permite crear con rapidez y facilidad sus propios membretes personalizados. Seleccione esta función para centrar automáticamente el texto y ajustar la longitud de la cinta y los márgenes a un formato perfecto para los soportes de películas de membrete entintados. Puesto que el soporte del membrete es reutilizable, haga nuevos membretes reemplazando la película del membrete en el soporte de películas.

 *Conserve el soporte de películas de membrete fuera del alcance de los niños. Evite que los ojos o la boca entren en contacto con la tinta. Si le entra tinta en los ojos o en la boca, lávese inmediatamente los ojos o la boca con agua fresca durante varios minutos y vaya al médico.*

*Mantenga la tinta apartada de la piel, ropas y papeles importantes. Emplee inmediatamente jabón para lavarse la piel que haya entrado en contacto con la tinta.*

*Incluso lavándose, es posible que no desaparezca toda la tinta.*

## PARA HACER UN MEMBRETE:

- 1 Inserte un cassette de película de membretes del tamaño deseado en el compartimiento de la cinta.
- 2 Mantenga presionado  y presione . El indicador **Stamp** se encenderá y se visualizará el ajuste de STAMP FORMAT para el cassette de cinta instalado. Si se ha instalado un cassette de película de membretes de 18 mm (3/4") de ancho, aparecerá STAMP M debajo del ajuste STAMP FORMAT; si se ha instalado un cassette de película de membretes de 24 mm (1") de ancho, aparecerá STAMP L debajo del ajuste STAMP FORMAT.
- 3  *Si el texto ya se ha introducido en el visualizador, aparecerá el mensaje "OK TO CLEAR TEXT BUFFER?". Presione  para borrar el texto.*
- 4 Presione .

6 Presione . El mensaje "WORKING" aparecerá en el visualizador justo antes de iniciarse la impresión, y luego se visualizará "COPY STAMP TAPE " mientras se corta el texto de la película de membretes. Después, usted podrá seleccionar el ajuste EDIT STAMP para editar el texto del membrete, o el ajuste FINISH STAMP para que el visualizador vuelva al modo WYSIWYG (se apaga el indicador **Stamp** ).

*☞ Cuando imprima caracteres grandes o a temperaturas bajas, la calidad del membrete podrá mejorarse si se conecta el adaptador de CA.*

7 Después de haberse cortado la película de membretes, extraiga el papel del dorso del membrete adhiéralo al tampón de tinta o soporte de películas.

*☞ Si el soporte del membrete ya contiene una película membretes, sujete el membrete encima de un trozo de papel y extraiga el marco del membrete separando sus extremos uno por uno. Luego, pele lentamente la película de membretes. Tenga cuidado de no salpicar tinta.*

# FUNCIÓN DE IMPRESIÓN ESPECIAL (Special Print)

La función **Special Print** la permite ajustar el número de copias de la etiqueta que se imprimirán, ajustar si la máquina corta automáticamente cada etiqueta, y activar y desactivar la función de impresión dividida.

Parámetros	Ajustes
COPIES (número de copias de la Etiqueta que se imprimirán)	1 a 99
A. CUT (corte automático de cada etiqueta después de la impresión)	ON, OFF
SPLIT (división de la etiqueta longitudinalmente e impresión como dos etiquetas)	OFF, ON

Los ajustes de fábrica son COPIES ajustado a 1, A. CUT ajustado a ON, y SPLIT ajustado a OFF.

 Cuando el parámetro SPLIT se ajusta a ON, se ignora el parámetro COPIES y sólo se imprime una copia de la etiqueta.

Los ajustes seleccionados para estos parámetros se ignoran durante la impresión en color.

## PARA CAMBIAR EL AJUSTE DE UN PARÁMETRO DE LA FUNCIÓN DE IMPRESIÓN ESPECIAL:

1 Mantenga presionado  y presione

2 Presione  o  hasta que se ilumine el ajuste del parámetro que desee cambiar.

3 Presione  o  hasta que se visualice el ajuste deseado.

 Cuando se ajuste el parámetro COPIES, presionando la tecla una vez se cambia el ajuste en 1. Sin embargo, si una de estas teclas se mantiene presionada, el ajuste sigue cambiando en pasos de 5 hasta que se suelte la tecla.

Para seleccionar el ajuste inicial de fábrica, presione .

Para cambiar todos los parámetros a los ajustes iniciales de fábrica, mantenga presionado  y presione .

4 Repita los pasos 2 y 3 hasta que haya ajustado todos los parámetros como desee.

5 Presione . Las etiquetas se imprimirán con los ajustes de los parámetros seleccionados.

Si el parámetro SPLIT está ajustado a ON, las etiquetas como las mostradas arriba se imprimirán. Para colocarlas juntas de forma que no se dividan los caracteres, corte el espacio en blanco de la parte inferior de la etiqueta superior, y la parte superior de la etiqueta inferior.

 Cuando el parámetro SPLIT está activado, solamente se imprimirá una copia completa de la etiqueta, independientemente del ajuste del parámetro de copias.







# FUNCIÓN DE NUMERACIÓN SECUENCIAL (Seq. Numbering)





La función de numeración secuencial (**Seq. Numbering**) puede utilizarse para imprimir varias copias del mismo texto mientras se incrementan ciertos caracteres (letras o números) después de imprimirse cada etiqueta. Este tipo de incremento automático es muy útil para imprimir etiquetas con numeración secuencial, para producir etiquetas de control u otras etiquetas que requieren códigos con incremento ascendente.



 *El texto sólo puede contener un campo numérico.*

*Si incluye un carácter que no es alfanumérico, como por ejemplo un símbolo en el campo de numeración, sólo se incrementarán las letras y números del campo numérico cuando se impriman las etiquetas, o sólo se imprimirá una etiqueta si se incluye un carácter que no es alfanumérico en el campo.*

## PARA IMPRIMIR ETIQUETAS CON CARACTERES EN EL CAMPO DE NUMERACIÓN:

- 1 Presione , ,  o  para situar el cursor a la izquierda del primer carácter (letra o número) que desee incluir el campo de numeración.
- 2 Mantenga presionado  y presione . Aparecerá el mensaje "SELECT FIELD!" en el visualizador y se iluminará el primer carácter.





 *Para abandonar la función **Seq. Numbering** en cualquier momento, presione  (o mantenga presionado  y presione .*

- 3 Presione ,  hasta que se iluminen todos los caracteres que usted desea incluir en el campo.



 *Para el campo de numeración pueden seleccionarse hasta cinco caracteres como máximo. Si se seleccionan más de cinco caracteres, aparecerá el mensaje de error "WRONG SELECT" en el visualizador.*

*Un campo de numeración debe situarse por entero dentro de una línea de texto de un mismo bloque. Si trata de incluir texto de dos líneas distintas o de dos bloques distintos en el campo de numeración, aparecerá el mensaje de error "INVAL. CHARS!" en el visualizador.*

*El campo de numeración no puede contener caracteres con ajustes de formatos distintos. Si trata de seleccionar caracteres con ajustes de formatos distintos, aparecerá el mensaje de error "WRONG SELECT" en el visualizador.*

- 4 Presione . Aparecerá el ajuste de NUMBER en el visualizador.
- 5 Presione  o  hasta que se visualice el número de etiquetas que desee imprimir.
- 6 Presione  para inicial la impresión de las etiquetas. Aparecerá el mensaje "WORK-ING" en el visualizador justo antes de iniciarse la impresión, y luego se visualizará el número de cara copia mientras se imprime.

# TECLAS Store, Recall Y M.Del



Podrá emplear la memoria para almacenar texto que utilice con frecuencia. Estos archivos de texto permanecen en la memoria incluso después de emplear la función de reposición ( **Clear** ) para sacar los caracteres del visualizador (manteniendo presionado  y presionando ).



Cuando se almacena cada archivo, se le da un número para poderlo abrir posteriormente con facilidad. En la memoria pueden almacenarse hasta 100 archivos de texto o hasta nnos 3.000 caracteres en la P-touch 550 (o 1.000 caracteres en la P-touch 530).

Puesto que se llama una copia del archivo de texto almacenado cuando se emplea la función de llamada ( **Recall** ), puede editarse o imprimirse el texto sin cambiar el archivo original. Cuando un archivo deja de ser necesario, podrá emplear la función **M.Del** para borrarlo.

## PARA ALMACENAR UN ARCHIVO DE TEXTO EN LA MEMORIA:

❶ Mantenga presionado  y presione .

*☞ Para abandonar la función **Store** en cualquier momento sin almacenar el texto, presione  (o mantenga presionado  y presione ).*

❷ Presione  o  hasta que se visualice el número de archivo en el que desee almacenar el texto.

*☞ El numero de los archivos que todavía estan vacios se ilumina cuando se visualiza. El numero de los archivos que ya contiecen texto no se ilumina y se muestra su texto en el visualizador.*

❸ Presione . El texto se almacena en el número de archivo seleccionado.











*☞ Si ya se ha almacenado un archivo de texto con el mismo número de archivo seleccionado, aparecerá el mensaje "OVERWRITE?" y usted deberá decidir si lo sobreescribe o no (es decir, si lo borra de la memoria almacenar el nuevo texto).*

## Para sobreescribir el archivo almacenado con el archivo nuevo















❹ Presione . El archivo previamente almacenado se borrará y se almacenará el nuevo en el número seleccionado.

*☞ Para retroceder y seleccionar otro número de archivo sin sobreescribir el archivo de texto, presione .*



## PARA LLAMAR UN ARCHIVO DE TEXTO DE LA MEMORIA:

- 1 Mantenga presionado  y presione . Se visualizarán el número y los primeros caracteres del archivo más recientemente almacenado o llamado.  
*☞ Para abandonar la función Recall en cualquier momento sin llamar texto, presione  (o mantenga presionado  y presione ).*
- 2 Presione  o  hasta que se visualice el archivo que usted desea llamar.  
*☞ Para explorar por el archivo de texto que se visualiza, presione  o .*
- 3 Presione . Se visualizará el texto almacenado en el número de archivo seleccionado.  
*☞ Si se había introducido el texto en el visualizador antes de iniciarse la función Recall, se borrará el texto del visualizador al visualizarse el texto llamado.*

## PARA BORRAR UN ARCHIVO DE TEXTO DE LA MEMORIA:

- 1 Mantenga presionado  y presione . Se visualizarán el número y los primeros caracteres del archivo más recientemente almacenado o llamado.  
*☞ Para abandonar la función M.Del en cualquier momento sin borrar un archivo de texto, presione  (o mantenga presionado  y presione .*
- 2 Presione  o  hasta que se visualice el archivo que usted desea borrar.  
*☞ Para explorar por el archivo de texto seleccionado, presione  o .*  
*Para seleccionar más de un archivo, seleccione cada archivo visualizándolo y presionando entonces  para iluminar el número. Para cancelar la selección del archivo, presione  hasta que el número no esté iluminado.*  
*Para seleccionar todos los archivos de la memoria, mantenga presionado  y presione . Para cancelar la selección de todos los archivos de la memoria, mantenga presionado  y presione .*



- 3 Presione . Se visualizará el mensaje "OK TO CLEAR?" o "CLEAR ALL".
- 4 Presione . El archivo o los archivos seleccionados se borrarán.

**brother**®

Printed in Japan  
UT0271001